



FLEXIBLE
BARRIERS
SAFER
WORKPLACE



CONTENTS

01	Rack Protections	page 12	09	Loading Bay Protections	page 60
02	Bollards	page 20	10	Column Protections	page 66
03	Cold Line	page 26	11	Corner Protections	page 72
04	Ground Level Protections	page 30	12	Kerb	page 76
05	Traffic Barriers	page 36	13	Wall Protections	page 80
06	Pedestrian Barriers	page 40	14	Accessories	page 86
07	Gates	page 50	15	Tech Solutions	page 94
08	Industrial Door Protections	page 56			



mipm
FLEXIBLE PROTECTIONS
WAREHOUSE

mipm
FLEXIBLE PROTECTIONS

Flexible safety solutions

To make work environments safe wherever there is movement of vehicles, goods and people.

Soluzioni di sicurezza flessibili

Per rendere sicuri gli ambienti di lavoro ovunque ci sia movimento di veicoli, merci e persone.

Solutions de sécurité flexibles

Pour rendre les environnements de travail sûrs lorsqu'il y a un mouvement de véhicules, de marchandises et de personnes.

Soluciones flexibles de seguridad

Hace más seguros los entornos de trabajo donde se mueven vehículos, mercancías y personas.

MPM Materials

FIRE CERTIFICATION FOR MPM REFLEX

NEWS

OUR POLYMER CONFIRMS THE V0 SELF-EXTINGUISHING CLASS

MPM barriers are classified as V0, according to the international UL94 standard, Reflex technopolymer Protections:

- Low fire risk;
 - Self-extinguishing;
 - Don't spread flames and stop burning within few seconds.
- The installation of our barriers lowers fire risk, compared to other barriers made of alternative polymers, not V0-Classified.

Le barriere MPM sono classificate V0, secondo lo standard internazionale UL94. Le protezioni in tecnopolimero Reflex:

- Hanno un basso carico d'incendio;
- Sono autoestinguenti;
- Non propagano la fiamma e smettono di bruciare entro pochi secondi.

L'installazione delle nostre barriere riduce il carico d'incendio rispetto ad altre barriere in polimeri alternativi, non classificati V0.

Les barrières MPM sont classées V0, selon la norme internationale UL94. Les protections en technopolymère Reflex:

- Elles ont une charge d'incendie minimale;
- Elles sont auto-extinguibles;
- Elles ne propagent pas la flamme et cessent de brûler en quelques secondes.

La présence de nos barrières réduit la charge d'incendie par rapport à d'autres barrières en polymères alternatifs, non classées V0.

Las barreras MPM están clasificadas como V0, según la norma internacional UL94. Las protecciones de tecnopolimero Reflex:

- Tienen una baja carga de fuego;
- Son autoextinguibles;
- No propagan la llama y dejan de arder en unos segundos.

La instalación de nuestras barreras reduce la carga de fuego en comparación con otras barreras de polímero alternativos, no clasificadas como V0.



REFLEX QLFA

Highly UV-resistant
Maintains its colour
over time

REFLEX RESISTANT AND FLEXIBLE

FROSTEX RESISTANT TO LOW TEMPERATURES



Durability Through Time



High Flexibility



Compliance With EU Directive 2015/863 (RoHS)



100% Recyclable



Self Extinguishing V0



Anti-scratch Material



Coloured Material, No Repainting Required



Easy To Clean



Mold Resistant



Non-toxic



Resistant to Chemicals



Resistant to Humidity & Saline Substances



Temperature Range: -30° + 50° C



High Flexibility



Compliance With EU Directive 2015/863 (RoHS)



100% Recyclable



HB Flammability rating according to UL 94



Suitable for food contact



Coloured Material, No Repainting Required



Resistant to Chemicals



Mold Resistant



Non-toxic



Resistant to Humidity & Saline Substances

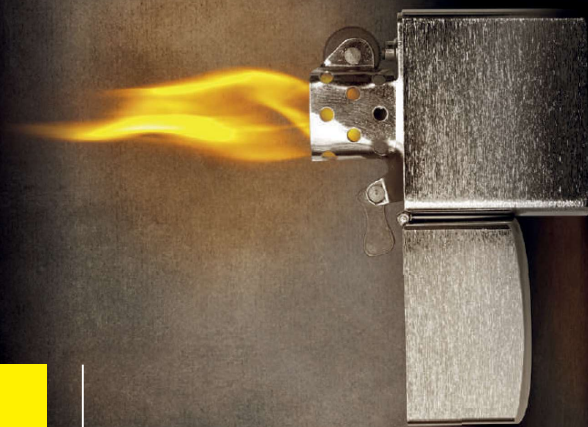

REFLEX RESISTANT AND FLEXIBLE

IS FIRE RESISTANT CLASS V-0



At MPM, we believe in a safer future from every perspective.

We produce solutions to keep people safe under all circumstances, and that's why we commit to making our production processes increasingly more sustainable.

MPM Green

We are a "closed-loop" company, connected to a network of external businesses that allows us to eliminate waste from our production chain by recycling the "excess" and processing it to give it new life.

All of our products become useful, one way or the other, and waste is always avoided.

Siamo un'azienda a "ciclo chiuso", collegata a una rete di imprese esterne che ci permette di eliminare gli sprechi dalla nostra catena di produzione riciclando le "eccedenze" e trattandole per dar loro una nuova vita.

Tutti i nostri prodotti diventano utili, in un modo o nell'altro, e gli sprechi sono sempre evitati.

WATER USAGE



All water used is internally recycled to reduce pollution and maximize its utilization.

Tutta l'acqua usata è internamente riciclata per ridurre l'inquinamento e massimizzare l'utilizzo.

Toute l'eau utilisée est recyclée en interne pour réduire la pollution et maximiser son utilisation.

Todo el agua utilizada se recicla internamente para reducir la contaminación y maximizar su uso.

ZERO WASTE GOAL



Our products are crafted from 100% recyclable, non-toxic materials.

I nostri prodotti sono realizzati con materiali al 100% riciclabili e non tossici.

Nos produits sont fabriqués avec des matériaux 100% recyclables et non toxiques.

Nuestros productos están hechos de materiales 100% reciclables y no tóxicos.

CLEAN ENERGY



Our Italian facilities rely on solar power, curbing carbon emissions.

Le nostre strutture in Italia usano energia solare, tagliando le emissioni di carbonio.

Nos installations italiennes fonctionnent à l'énergie solaire, ce qui réduit les émissions de carbone.

Nuestras instalaciones en Italia utilizan energía solar, reduciendo las emisiones de carbono.

MPM Systems

Innovation made simple

With our innovative complementary systems you can customize your solutions.

Con i nostri innovativi sistemi complementari puoi personalizzare le tue soluzioni.

Avec nos systèmes complémentaires innovants, vous pouvez personnaliser vos solutions.

Con nuestros sistemas complementarios innovadores, puedes personalizar tus soluciones.

STANDARD

Our STANDARD system is simple and intuitive to use thanks to its few components.

Il nostro sistema STANDARD è semplice e intuitivo da usare grazie alle poche componenti.

Notre système STANDARD est simple et intuitif à utiliser grâce à ses quelques composants.

Nuestro sistema estándar es simple e intuitivo de usar gracias a sus pocas componentes.

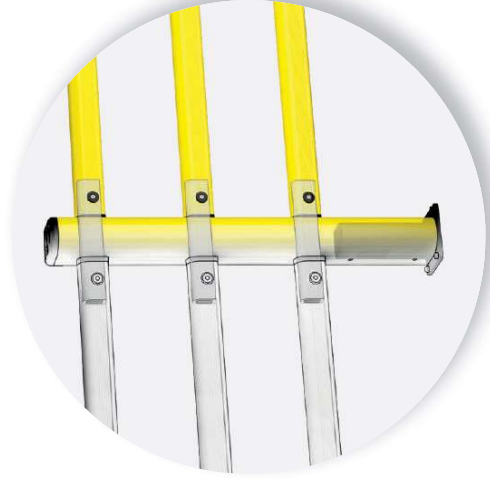
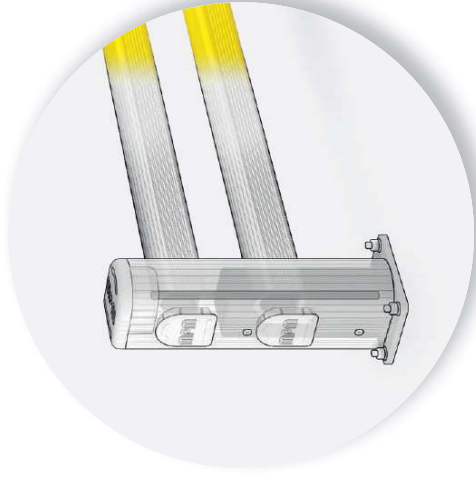

PIN

Enhanced strength and greater impact absorption

Maggiore resistenza e maggiore assorbimento degli impatti

Résistance accrue et absorption des chocs

Mayor resistencia y absorción de impactos

LINK

Customize crossbar height at any time

Personalizza l'altezza del traverso in qualsiasi momento

Personnalisez la hauteur de la barre transversale à tout moment

Personaliza la altura de la barra transversal en cualquier momento

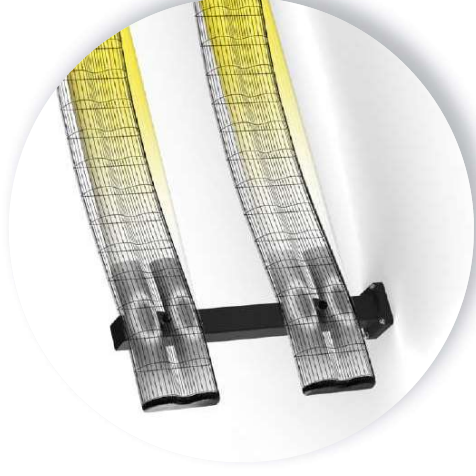

B-FLEX

Protection system with a reinforced profile, twice as flexible and shock-absorbent.

Sistema di protezione con profilo rinforzato, doppiamente flessibile e assorbente.

Système de protection avec profil renforcé, doublement flexible et absorbant.

Sistema de protección con perfil reforzado, más flexible y capaz de absorber perfectamente los impactos.

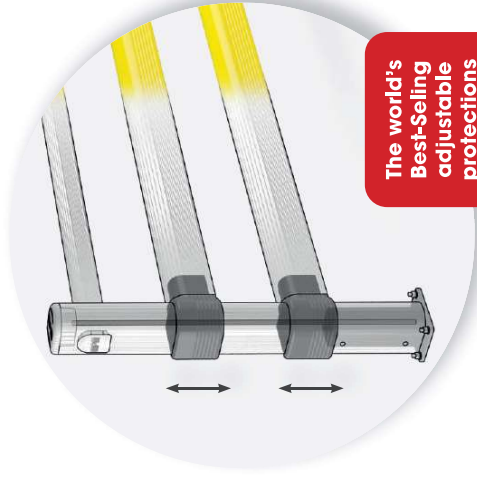

The world's Best-Selling adjustable protections system

Discover our systems!

Ask our team how to best use these innovative systems to meet your safety needs.

Chiedi al nostro team come utilizzare al meglio questi sistemi innovativi per soddisfare le tue esigenze di sicurezza.

Demandez à notre équipe comment utiliser au mieux ces systèmes innovants pour répondre à vos besoins en matière de sécurité.

Pregunta a nuestro equipo cómo utilizar de la mejor manera estos sistemas innovadores para satisfacer tus necesidades de seguridad.



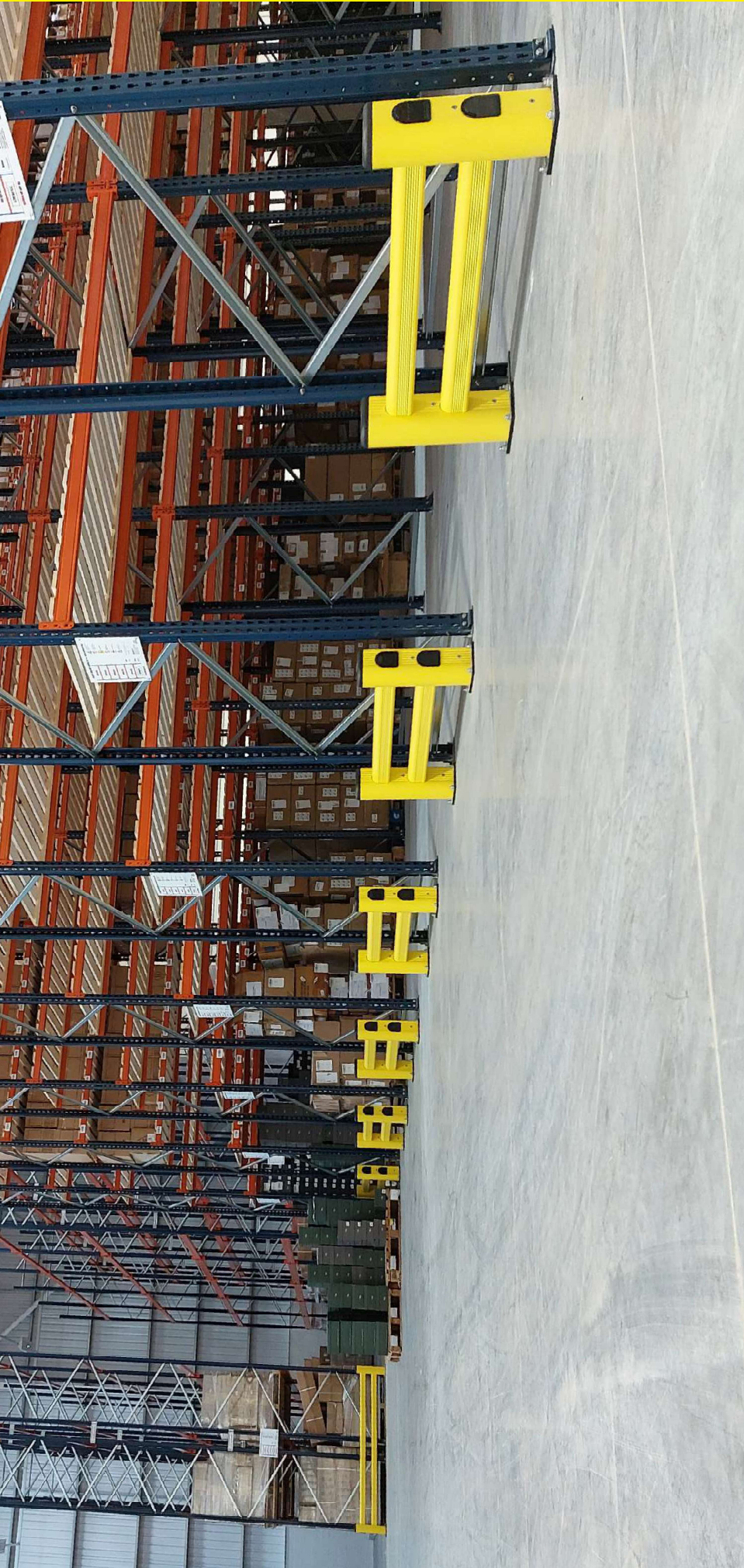

RACK PROTECTIONS

01

OUR PROFILES FIT ALL RACKS

Full range of technopolymer profiles for protection of rackings.

Gamma completa di profili in tecnopolimero per la protezione delle scaffalature.

Complète gamme de profils en technopolimère pour la protection d'étagères.

Gama completa de perfiles de tecnopolímeros para las protecciones de estanterías.

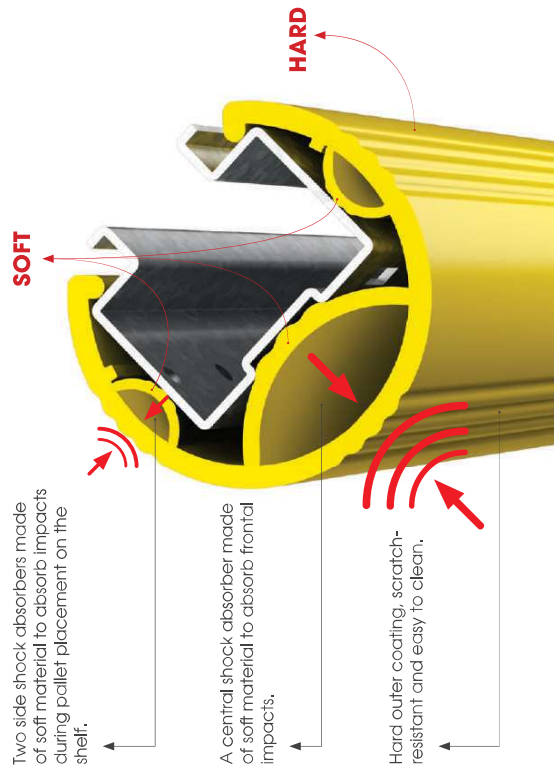

RACK PROTECTOR

TECHNICAL RACK

EASY TO INSTALL
WITH RP CLICK



SOFT MATERIAL
INSIDE



CUSTOMIZED
SOLUTIONS TO
FIT ALL UPRIGHTS



Available for



Available for



RESISTANT TO
LOW TEMPERATURES

EASY TO
INSTALL WITH

HOOK
AND LOOP
CLOSURE

NEW

RPS



Model **Small**
Height **400, 600 mm**
Packing **6 pcs / box**
Packing **115 pcs / big parcel**
Colour ●

RPM



Model **Medium**
Height **400, 600 mm**
Packing **4 pcs / box**
Packing **80 pcs / big parcel**
Colour ●

RPL



Model **Large**
Height **400, 600 mm**
Packing **2 pcs / box**
Packing **52 pcs / big parcel**
Colour ●

RPL XL



Model **Extra Large**
Height **600 mm**
Packing **To be defined**
Colour ●

TRS

Model **Small**
Height **550 mm**
Packing **15 pcs / box**
Packing **120 pcs / big parcel**
Colour ●

TRM

Model **Medium**
Height **550 mm**
Packing **12 pcs / box**
Packing **96 pcs / big parcel**
Colour ●

TRL

Model **Large**
Height **550 mm**
Packing **9 pcs / box**
Packing **72 pcs / big parcel**
Colour ●

RACK CORNER



RACK CORNER



Heavy Load
 Height 500 mm
 Fixing Included
 Colour ●



LM



Ask us about our
**2-UNITS RACK
 END BARRIER**
 going up to
 4000mm width

SM RE



Light Load
 Height 350 mm
 Width 250 - 1500 mm
 (50 increments)
 Included
 Colour ● ● ●

LM RE



Heavy Load
 Height 420 mm
 Width 250 - 2400 mm
 (50 increments)
 Included
 Colour ● ● ●

LINK SINGLE RE



Heavy Load
 Height 500, 800 mm
 Width 400 - 2400 mm
 (50 increments)
 Included
 Colour ● ● ●

LM/1 LINK RE



Heavy Load
 Height 420 mm
 Width 400 - 2400 mm
 (50 increments)
 Included
 Colour ● ● ●

LINK LM RE



Heavy Load
 Height 500, 800 mm
 Width 400 - 2400 mm
 (50 increments)
 Fixing Included
 Colour ● ● ●



FENCE



BFLEX

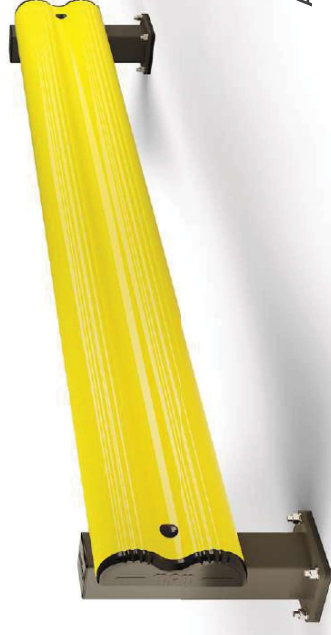

SHOCK
ABSORBER PAD



INCLUDED

FENCE 90



Height 400 mm
Width 300 - 2400 mm
Fixing Included
Colour ●●

FENCE 150



Height 550 mm
Width 400 - 2400 mm
Fixing Included
Colour ●●●

FENCE 150 REF



Height 550 mm
Width 400 - 2400 mm
Fixing Included
Colour ●●●

FENCE LINK



Height 550 mm
Width 400 - 2400 mm
Fixing Included
Colour ●●●

BFLEX.FRONT/1 RE



Height 450 mm
Width 250 - 2400 mm
Fixing Included
Colour ●●

BFLEX.COM/1 RE



Height 450 mm
Width 550 - 2400 mm
Fixing Included
Colour ●●





Designed to protect gates, doors and all sensible structures in warehouses and logistic areas.

Progettati per proteggere cancelli, porte e tutte le strutture sensibili in magazzini e aree logistiche.

Conçus pour protéger les portails, les portes et toutes les structures sensibles dans les entrepôts et les zones logistiques.

Diseñados para proteger puertas, portones y todas las estructuras sensibles en almacenes y áreas logísticas.

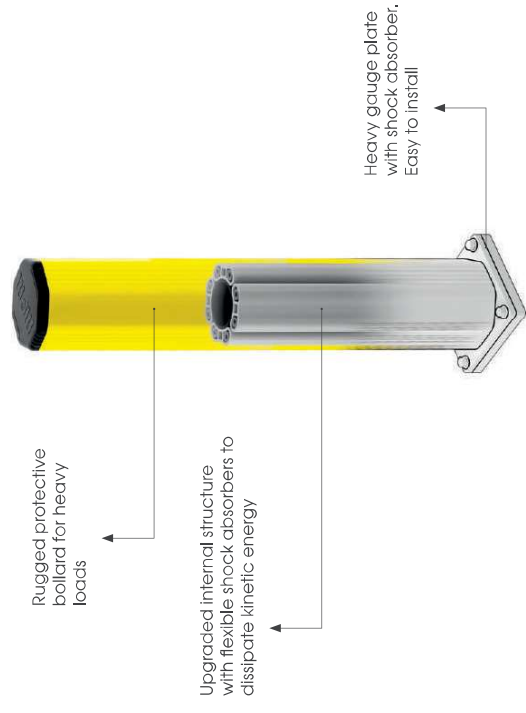

Rugged protective bollard for heavy loads

Upgraded internal structure with flexible shock absorbers to dissipate kinetic energy

Heavy gauge plate with shock absorber. Easy to install

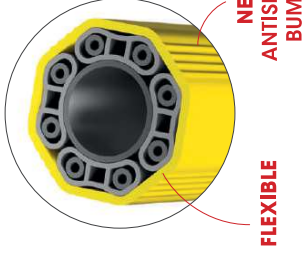
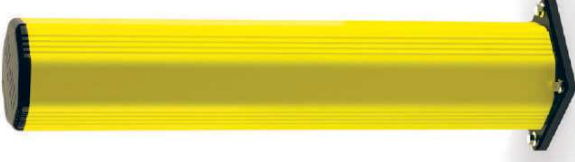

GRD 90



Light Load

Height 250, 1150 mm
Fixing Included
Colour ●●

GRD 150



Heavy Load

Height 500, 800, 1150 mm
Fixing Included
Colour ●●●

GRD 150 PLUS



Heavy Load

Height 500, 800, 1150 mm
Fixing Included
Colour ●●●

SHOCK ABSORBER PAD INCLUDED FOR PLUS



GRD 200



Heavy Load

Height 800, 1200, 2000 mm
Fixing Included
Colour ●●●

SHOCK ABSORBER PAD INCLUDED



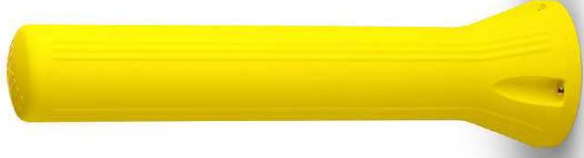

ROCKET BOLLARD



NEW



NEW TECHNOLOGY



RESISTANT TO LOW TEMPERATURES



INNOVATIVE MATERIAL



ROCKET BOLLARD 150



Height 500 mm
Fixing Included
Colour ●



ROCKET BOLLARD 200



Height 800, 1200 mm
Fixing Included
Colour ●



SINGLE-COMPONENT DESIGN



NO METAL PLATE

The Bollard that absorbs impacts best, reducing recoil for forklift drivers.



Better Floor Protection

No issues in Corrosive or high-salinity Environments

Improved Hygiene

Patented Product



FROSTEX
RESISTANT TO LOW TEMPERATURES

-30° RESISTANT TO LOW TEMPERATURES

Specific solutions for protection of environments with negative temperatures. They are suitable to protect corners, entrances, gates, panels and walls in cold rooms

Soluzioni specifiche per la protezione di ambienti a temperatura negativa. Ideali per proteggere angoli sporgenti, accessi e portoni, pannelli e pareti di celle frigorifere.

Solutions spécifiques pour la protection des environnements à température négative. Idéal pour protéger les angles, les entrées et les portes, les panneaux et les murs des chambres froides.

Soluciones específicas para proteger los entornos de temperatura negativa. Son ideales para proteger esquinas, entradas y puertas, paneles y paredes de las cámaras frigoríficas.

Suitable for the food industry



Thanks to its hygienic structure it does not allow accumulation of dirt and bacteria

ROD



ROD 70

ROD 120



Height **266 mm**
Fixing **Included**
Colour **●**



Height **433, 560, 800 mm**
Fixing **Included**
Colour **●**



ROD FLOOR



NO SHARP EDGES

RF 70



Height **110 mm**
Length **500, 1000, 1500, 2000, 3000 mm**
Fixing **Included**
Colour **●**

RF 100



Height **135 mm**
Length **500, 1000, 1500, 2000, 3000 mm**
Fixing **Included**
Colour **●**

RF 120



Height **140 mm**
Length **500, 1000, 1100, 1500, 2000, 2500, 3000 mm**
Fixing **Included**
Colour **●**

RF 120 DOUBLE



Height **400 mm**
Length **500, 1000, 1100, 1500, 2000, 2500, 3000 mm**
Fixing **Included**
Colour **●**

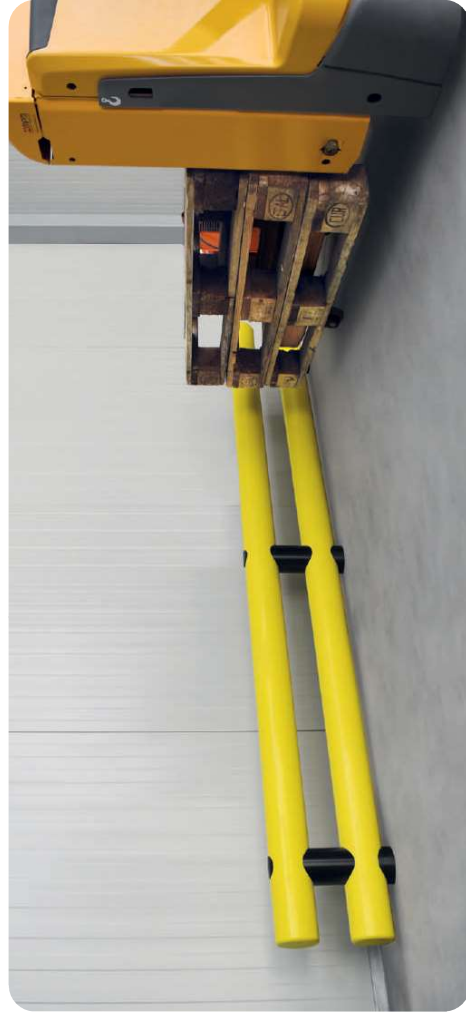



Bumper systems designed to prevent damages to structures and to protect from low forks of forklifts.

Sistemi antiurto pensati per prevenire i danni alle strutture e per proteggere dalle forche basse dei carrelli elevatori.

Systèmes de pare-chocs conçus pour prévenir les dommages aux structures et protéger contre les fourches basses des chariots élévateurs.

Sistemas de parachoques diseñados para prevenir daños en las estructuras y proteger contra las horquillas bajas de los carretes elevadores.

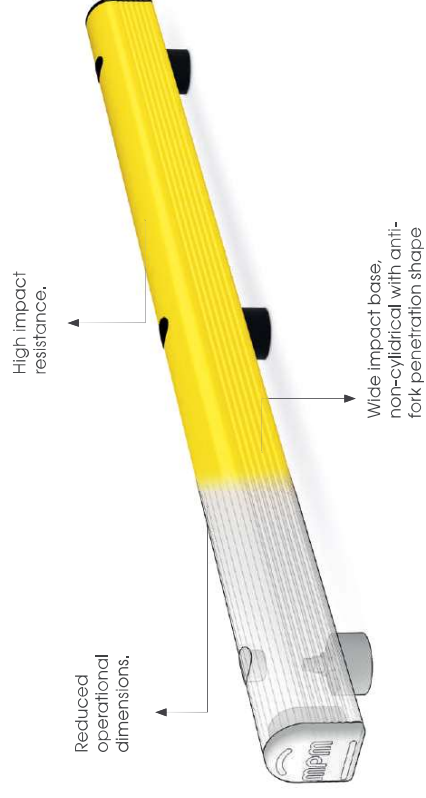

GR



GR 90



Height 140 mm
Length 500, 750, 1000, 1500, 2000, 3000, 4000 mm
Included ●
Colour ●

GR 150



Height 200 mm
Length 500, 750, 1000, 1250, 1500, 1750, 2000, 2250, 2500, 3000, 4000 mm
Included ●
Colour ●

NEW

GUARDIAN



HIGH IMPACT SURFACE

TRUCK LINE



Height 150 mm
Length 500, 750, 1000, 1250, 1500, 1750, 2000, 2250, 2500, 3000, 4000 mm
Included ●
Colour ●

GUARDIAN 200



Height 200 mm
Standard Module 500, 750, 1000, 1250, 1500, 1750, 2000, 2250, 2500, 3000, 4000 mm
Included ●
Colour ●

GUARDIAN 300



Height 300 mm
Standard Module 500, 750, 1000, 1250, 1500, 1750, 2000, 2250, 2500, 3000 mm
Included ●
Colour ●



GRIN

NEW

GR MODULAR



GRIN 90



Light Load
 Height 140 mm
 Standard Module (50 Increments)
 Fixing Included
 Colour ●●

GRIN 150



Heavy Load
 Height 200 mm
 Standard Module (50 Increments)
 Fixing Included
 Colour ●●

GR 150 Modular



Heavy Load
 Height 200 mm
 Standard Module (50 Increments)
 Fixing Included
 Colour ●●

TRUCK LINE Modular



Heavy Load
 Height 150 mm
 Standard Module (50 Increments)
 Fixing Included
 Colour ●●

GUARDIAN 200 Modular



Heavy Load
 Height 200 mm
 Standard Module (50 Increments)
 Fixing Included
 Colour ●●

GUARDIAN 300 Modular



Heavy Load
 Height 300 mm
 Standard Module (50 Increments)
 Fixing Included
 Colour ●●





Traffic barriers are a solution designed for the protection of people, infrastructures, machinery, and for the demarcation of moving vehicles.

Le barriere antiurto sono una soluzione studiata per la protezione di persone, infrastrutture, macchinari e per la delimitazione di veicoli in movimento.

Les barrières de circulation sont une solution conçue pour la protection des personnes, des infrastructures, des machines et pour la délimitation des véhicules en mouvement.

Las barreras anti golpes para vehículos son una solución diseñada para la protección de personas, infraestructuras, maquinaria y para la delimitación de vehículos en movimiento.

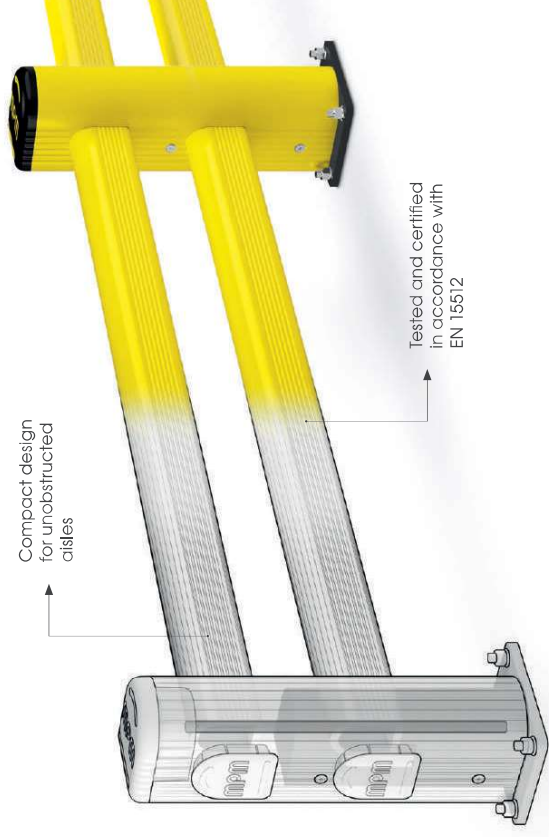

LM MODULAR



BFLEX MODULAR



**SHOCK
ABSORBER PAD
INCLUDED**



LM MODULAR



LM MODULAR



LM MODULAR



LM MODULAR



LM MODULAR



LM MODULAR



LM MODULAR



LM MODULAR



LM MODULAR



LM MODULAR



LM MODULAR



LM MODULAR



LM MODULAR



LM MODULAR



LM MODULAR



LM MODULAR



LM MODULAR



LM MODULAR



LM MODULAR



LM MODULAR



LM MODULAR



LM MODULAR



LM MODULAR



LM MODULAR



LM MODULAR



LM MODULAR



LM MODULAR



SM Modular

Light Load
Height 350 mm
Standard Module 250 - 1500 mm (250 increments)
Fixing Included
Colour ●●●



LM Modular

Heavy Load
Height 420 mm
Standard Module 250 - 2000 mm (250 increments)
Fixing Included
Colour ●●●



LINK SINGLE Modular

Heavy Load
Height 500, 800 mm
Standard Module 500 - 2000 mm (250 increments)
Fixing Included
Corner External Available
Colour ●●●



LM/1 LINK Modular

Heavy Load
Height 420 mm
Standard Module 500 - 2000 mm (250 increments)
Fixing Included
Corner External Available
Colour ●●●



LINK LM Modular

Heavy Load
Height 500, 800 mm
Standard Module 500 - 2000 mm (250 increments)
Fixing Included
Corner External Available
Colour ●●●



BFLEX.FRONT/1 Modular

Heavy Load
Height 450 mm
Standard Module 750 - 2000 mm (250 increments)
Fixing Included
Corner Available
Colour ●●●



BFLEX.COM/1 Modular

Heavy Load
Height 450 mm
Standard Module 750 - 2000 mm (250 increments)
Fixing Included
Corner Available
Colour ●●●





New system specific for the protection of pedestrians and resistant to forklift movements with different load types.

Sistema di profili antiurto specifico per la protezione delle aree pedonali dai carrelli in movimento con diverse portate di carico.

Système bumper, spécifique pour protéger les zones piétonnes contre les mouvements des chariots.

Sistema específico de perfiles antichoque para la protección de zonas peatonales de carros en movimiento con diferentes capacidades de carga.

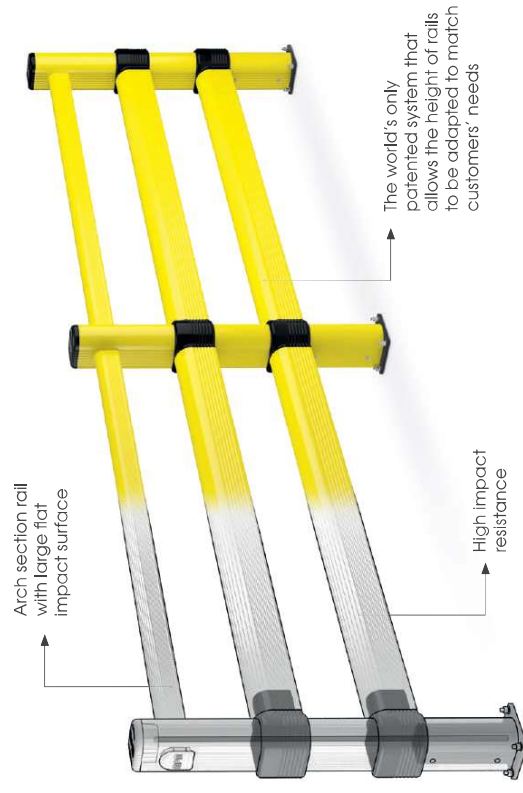

PEDESTRIAN 90

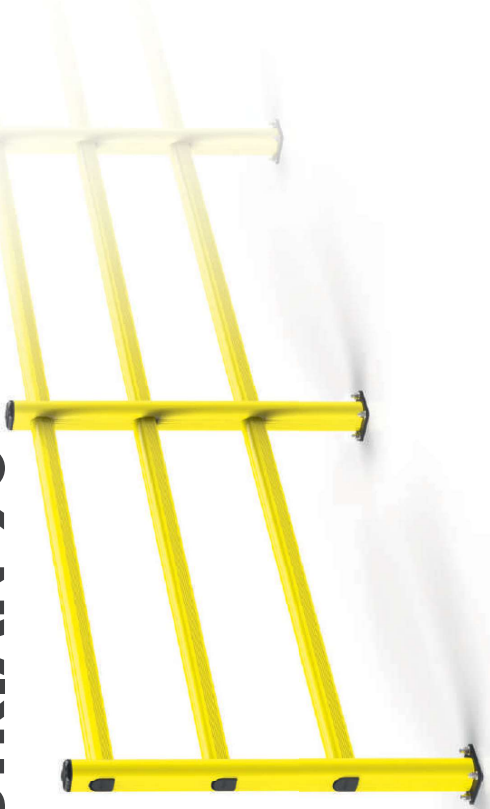

LINK 120



HAND RAIL



Light Load
 Height 1100 mm
 Standard Module (250 Increments)
 Corner Fixing Included
 Colour ●●●

PED 90



Light Load
 Height 1100 mm
 Standard Module (250 Increments)
 Corner Fixing Included
 Colour ●●●

PED 90 LINK



Heavy Load
 Height 1100 mm
 Standard Module (250 Increments)
 Fixing Included
 Colour ●●●

PED 90 GL REF



Heavy Load
 Height 1100 mm
 Standard Module (250 Increments)
 Fixing Included
 Colour ●●●

LINK 120/1



Heavy Load
 Height 1100 mm
 Standard Module (250 Increments)
 Fixing Included
 Colour ●●●

LINK 120/2



Heavy Load
 Height 1100 mm
 Standard Module (250 Increments)
 Fixing Included
 Colour ●●●

LINK 120/3



Heavy Load
 Height 1100 mm
 Standard Module (250 Increments)
 Fixing Included
 Colour ●●●



PEDESTRIAN 150

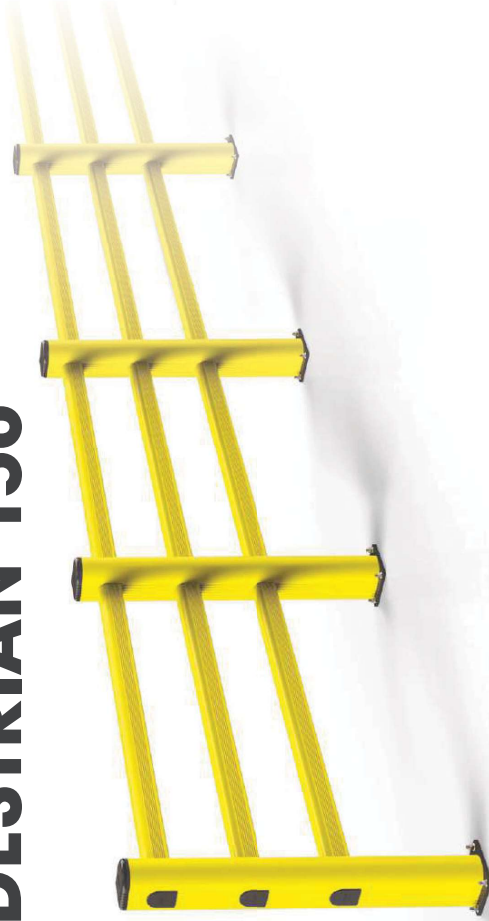

LINK 150



Height 1100 mm
Standard Module (250 Increments)

Corner Available
Fixing Included
Colour ●●

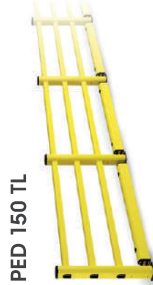

LINK 150 TL



Height 1100 mm
Standard Module (250 Increments)

Corner Available
Fixing Included
Colour ●●



LINK 150 G



Height 1100 mm
Standard Module (250 Increments)

Corner Available
Fixing Included
Colour ●●

LINK 150

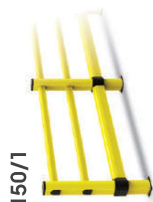

LINK 150/1



Height 1100 mm
Standard Module (250 Increments)

Corner External Available
Fixing Included
Colour ●●



LINK 150/2





Height 1100 mm
Standard Module (250 Increments)

Corner External Available
Fixing Included
Colour ●●



PEDESTRIAN 150 LINK



-  Heavy Load
- Height 1100, 1500, 2000, 2500, 3000 mm
- Standard 500 - 2000 mm
- Module (250 Increments)
- Corner External Available
- Fixing Included
- Colour  

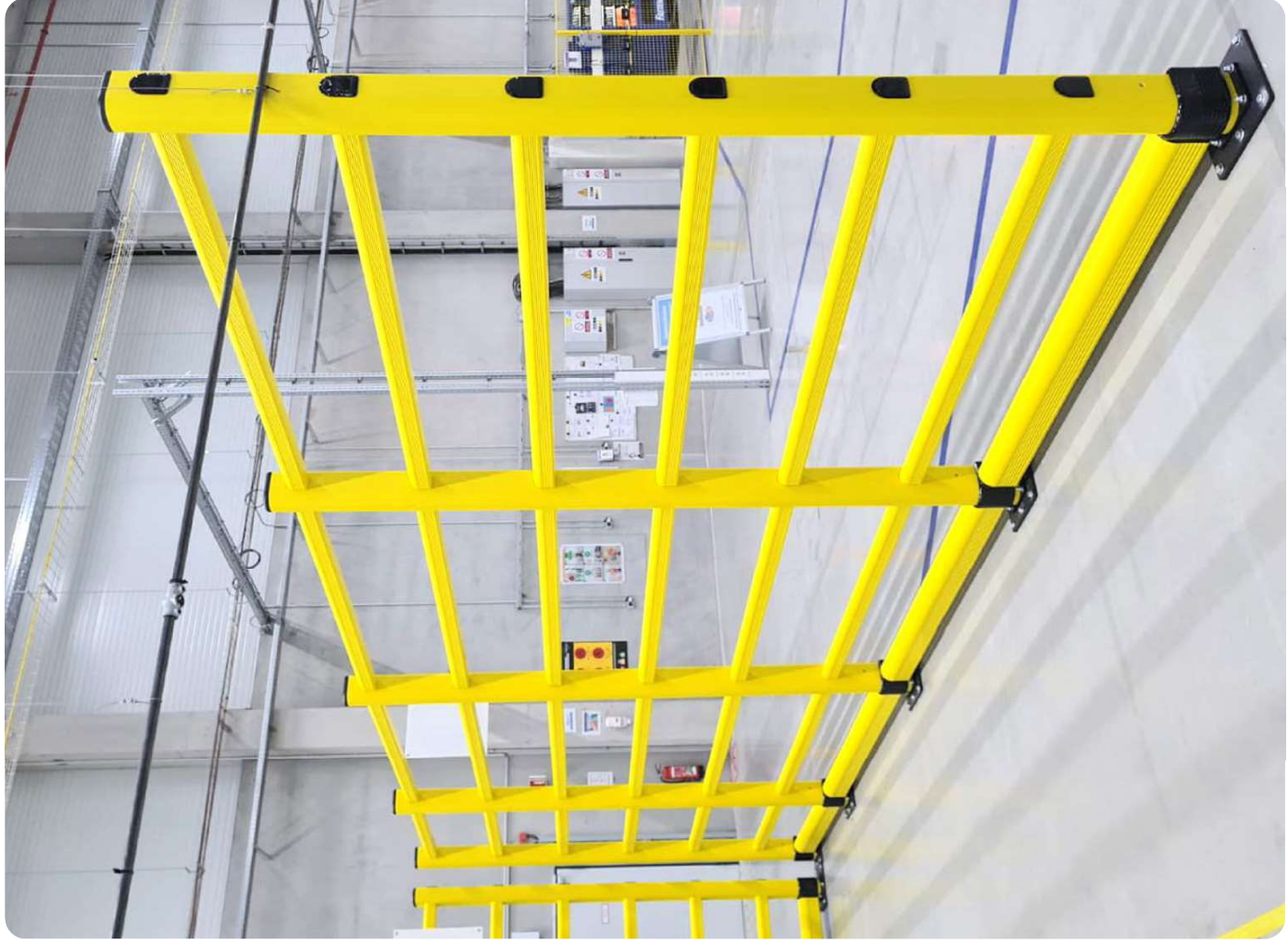
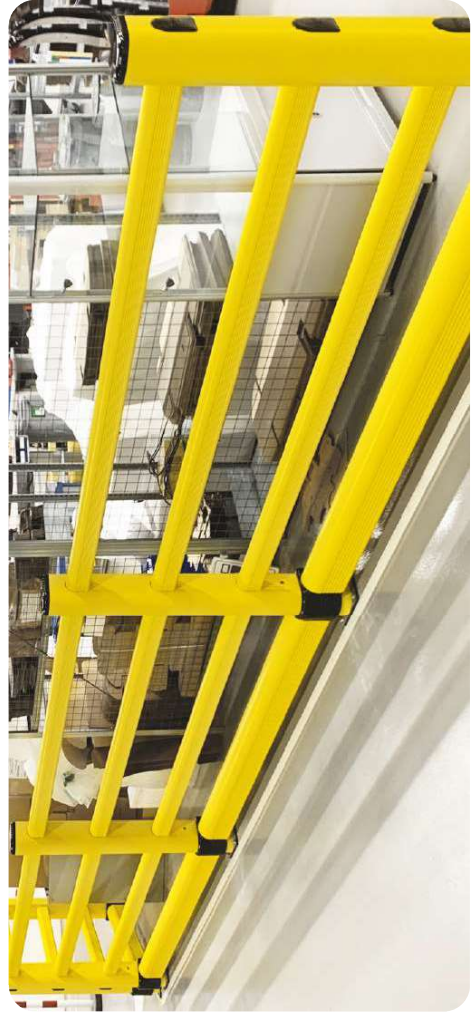

PIN



PED 150 PIN



Height 1100 mm
Standard Module (250 Increments)
Fixing Included
Colour ●●

PED 200 PIN



Height 1100 mm
Standard Module (250 Increments)
Fixing Included
Colour ●●



SHOCK ABSORBER PAD INCLUDED



BFLEX MODULAR



SHOCK ABSORBER PAD



INCLUDED

BFLEX_FRONT/2 Modular



Height 1100 mm
Standard Module (250 Increments)
Fixing Included
Colour ●●

BFLEX_COM/2 Modular



Height 1100 mm
Standard Module (250 Increments)
Corner Available
Fixing Included
Colour ●●





Safety Gate systems with different opening possibilities. Developed to complete our barriers for protection of pedestrian areas.

Sistema di cancelli di sicurezza progettato per completare le nostre barriere di protezione per aree pedonali.

Système de portillons étudié pour l'installation de nos barrières de protections pour les zones piétons.

Sistema de puertas diseñado para completar nuestras barreras peatonales.

Easy and intuitive opening mechanisms

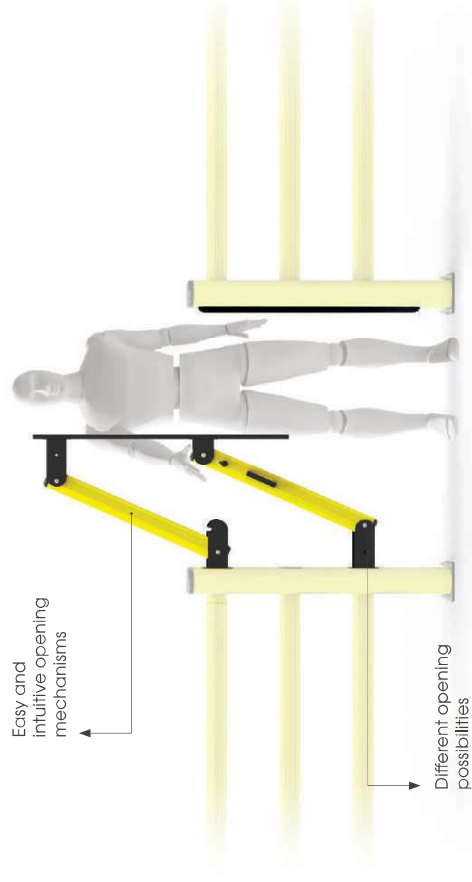

Different opening possibilities for maximum personalization

DOOR PEDESTRIAN 90

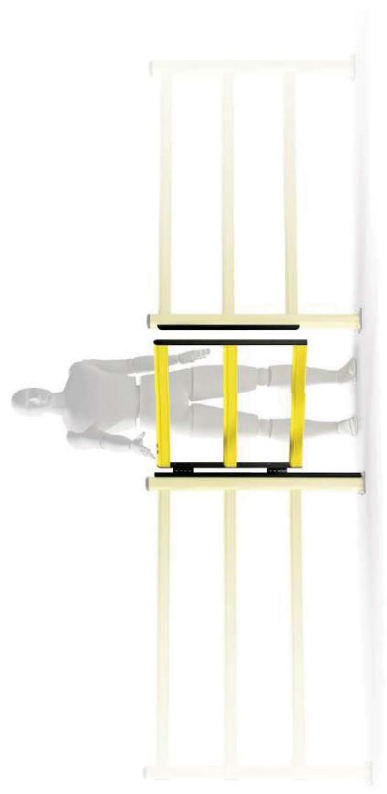

DP 90 ONE WAY



Width
Min 400 mm - Max 1000 mm
(50 increments)
Included
Colour

DP 90 SWING



Width
Min 400 mm - Max 1000 mm
(50 increments)
Included
Colour

DP 90 SWING DOUBLE



Width
Min 800 mm - Max 2000 mm
(50 increments)
Included
Colour



LIFT GATE 90



LIFT GATE 90



Width
Min 1050 mm - Max 1600 mm
(50 increments)
Included
Colour

LIFT GATE 90 DOUBLE



Width
Min 2100 mm - Max 3200 mm
(50 increments)
Included
Colour



DOOR PEDESTRIAN 150

Discover our new tech **SAFE WAY** on page 98

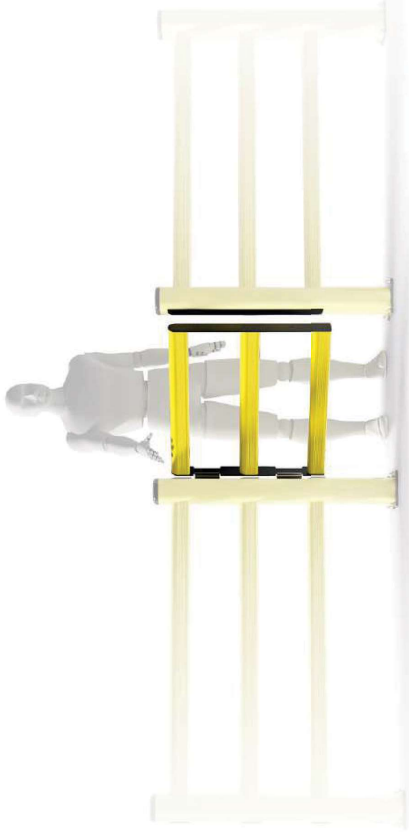

DP 150 ONE WAY



Width
Min 400 mm - Max 1000 mm
(50 increments)
Included
Fixing
Colour

DP 150 SWING



Width
Min 400 mm - Max 1000 mm
(50 increments)
Included
Fixing
Colour

DP 150 SWING DOUBLE



Width
Min 800 mm - Max 2000 mm
(50 increments)
Included
Fixing
Colour

LIFT GATE 150



LIFT GATE 150



Width
Min 1100 mm - Max 2000 mm
(50 increments)
Included
Fixing
Colour

LIFT GATE 150 DOUBLE



Width
Min 2200 mm - Max 4000 mm
(50 increments)
Included
Fixing
Colour

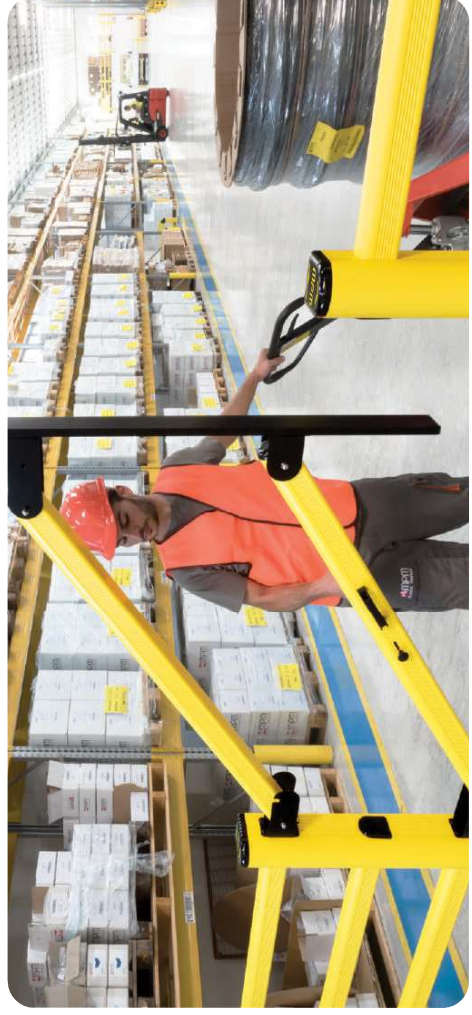

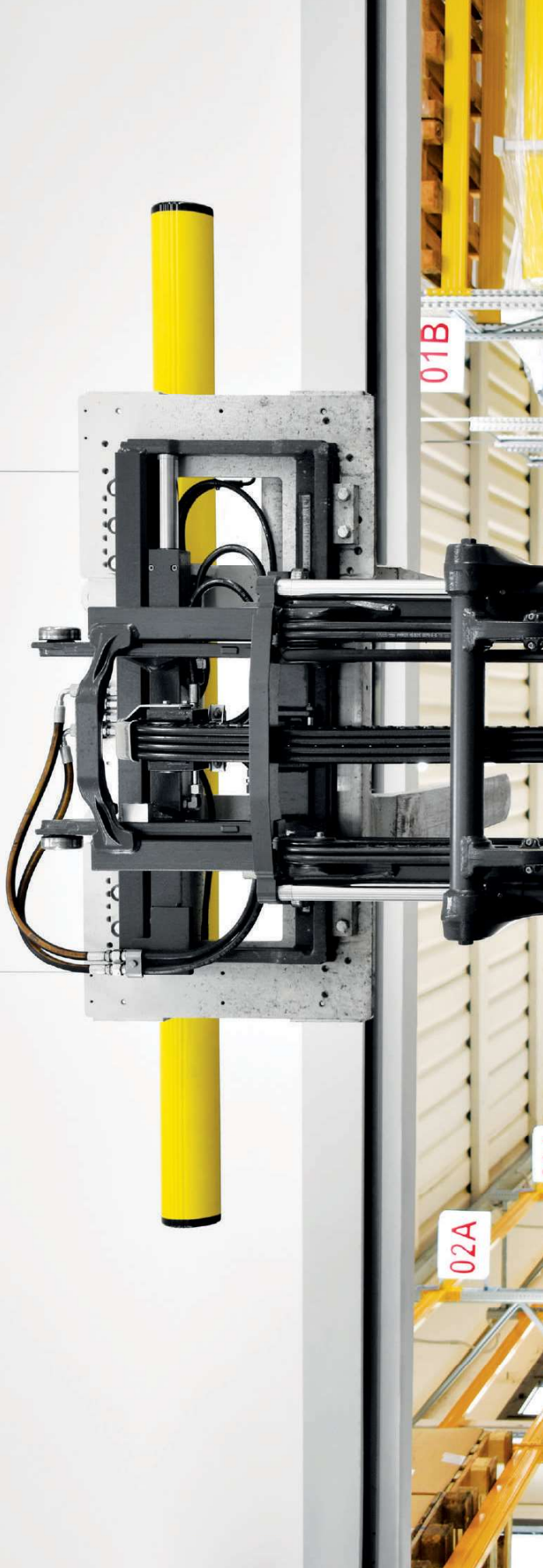

Protection system designed to prevent collisions with overhead infrastructure, gates and doors jambs. It is created to keep under control the passage of forklifts that exceed height limits.

Sistema di protezione ideato per prevenire le collisioni dei carrelli elevatori in movimento con le infrastrutture sopraelevate, gli stipiti di porte e portoni. Limita il passaggio di carrelli che superano i limiti di altezza.

Systèmes de protection conçus pour prévenir les collisions des chariots élévateurs en mouvement avec les infrastructures en hauteur et les montants des portes. Utiles pour empêcher le passage des chariots élévateurs qui dépassent les limites de hauteur.

Sistema de protección diseñado para evitar la colisión de carretillas elevadoras en movimiento con infraestructuras, instalaciones elevadas y marcos de puertas industriales. Diseñada para limitar el paso de las carretillas que superan los límites de altura.

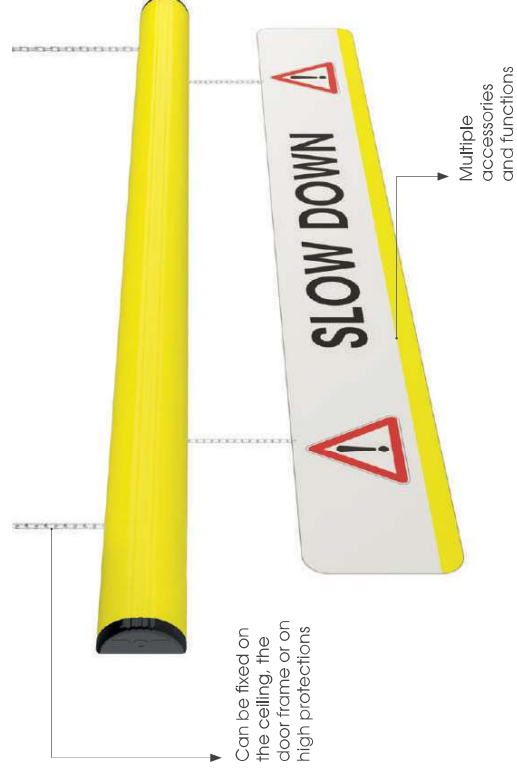

WARNING BAR

UP TO 70,000 IMPACTS!



WARNING BAR

Heavy Load
Length 2000, 3000 mm
Colour ●



WARNING BAR INFORMATION SIGN

Heavy Load
Length 2000, 3000 mm
Colour ●



WARNING BAR LIGHT & SOUND

Heavy Load
Length 2000, 3000 mm
Colour ●

102dB

FULL FRAME

INNOVATIVE BIGGER PLATES!



FOR SELF STANDING



FULL FRAME SELF STANDING

Heavy Load
Height UP to 5000 mm
Width up to 4500 mm
Fixing Included
Colour ●



FULL FRAME WALL FIXING

Heavy Load
Height To be defined
Width To be defined
Fixing Included
Colour ●



LOADING BAY PROTECTIONS

60

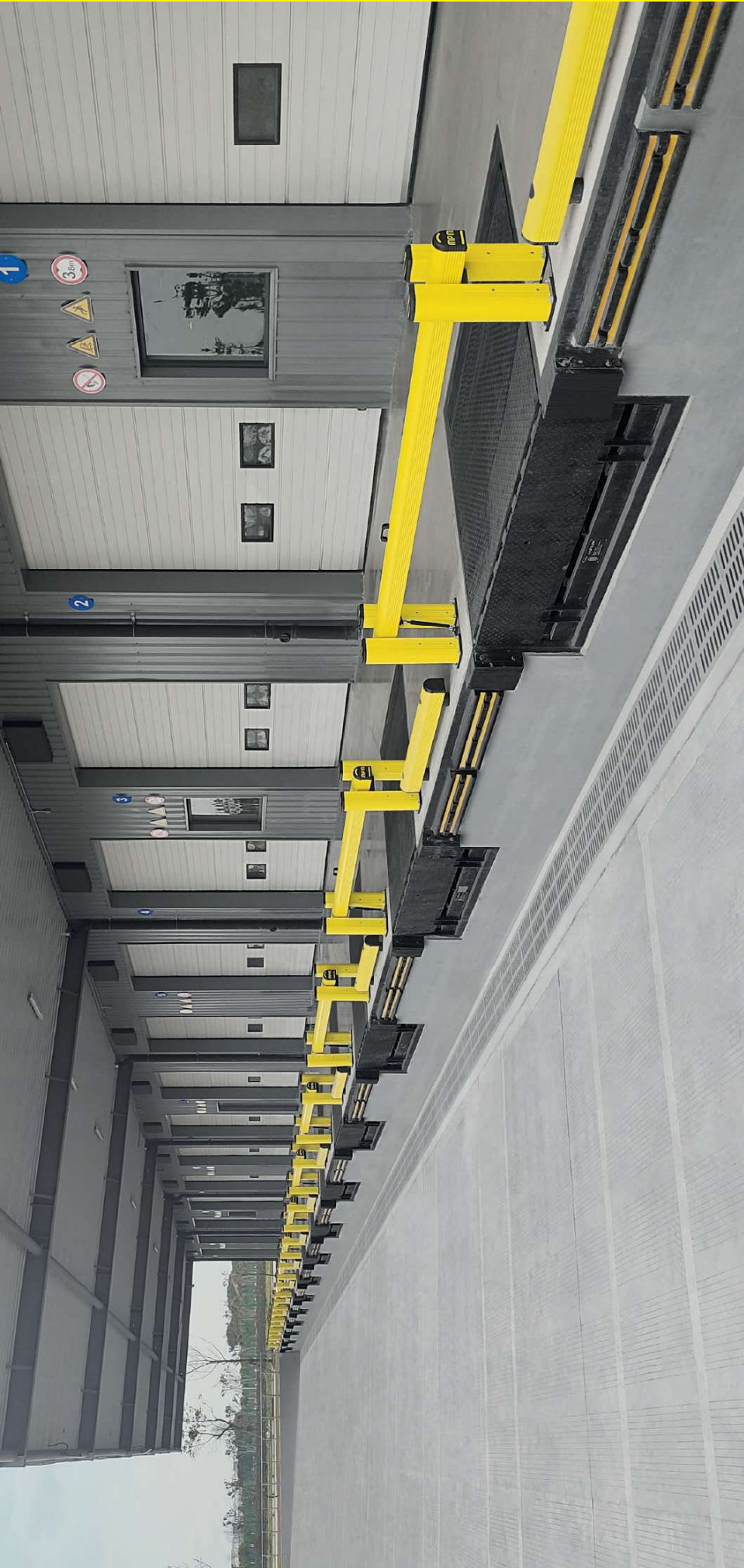

Impact protections designed for loading bays. They ensure safety for incoming vehicles and prevent damages.

Protezioni anti-urto progettate per le baie di carico. Garantiscono la sicurezza dei veicoli in arrivo e prevengono danni.

Protections contre les chocs conçues pour les quais de chargement. Elles garantissent la sécurité des véhicules entrants et préviennent les dommages.

Protecciones contra impactos diseñadas para muelles de carga. Aseguran la seguridad de los vehículos entrantes y previenen los daños.

Easy to open and close, yet impact resistant



DOCK GATE



HUG GATE



Height **1100 mm**
 Width **600 - 3000 mm (50 Increments)**
 Fixing **Included**
 Colour **●**



Height **640 mm**
 Width **L: 2400 - 2600 mm (50 Increments)
 XL: 2650 - 2800 mm (50 Increments)
 XXL: 2850 - 3000 mm (50 Increments)**
 Fixing **Included**
 Colour **● ●**

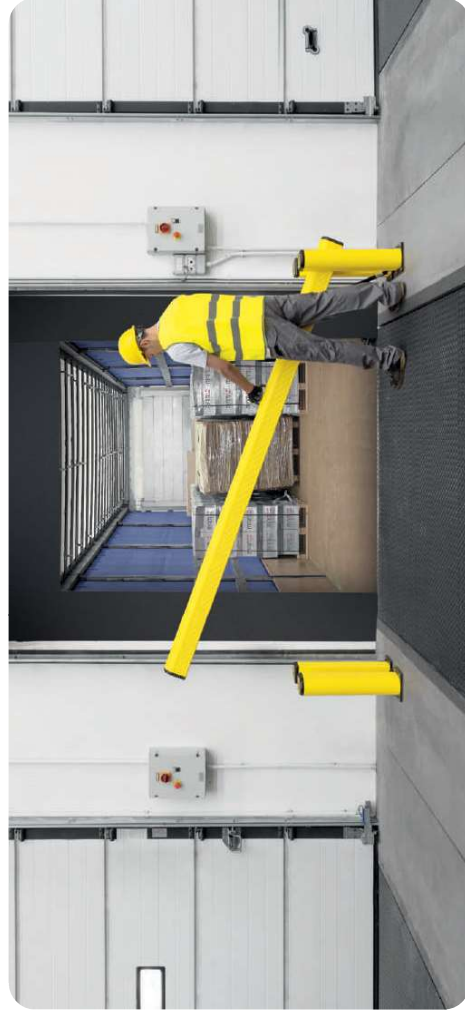

WHEEL STOP



CAR STOP



Height **90 mm**
 Width **1810 mm**
 Fixing **On Request**

TRUCK STOP



Height **150 mm**
 Width **1000 mm**
 Fixing **On Request**



DOCK BUMPER



DOCK BUMPER S



DOCK BUMPER



NEW

Height 400 mm
Width 110 mm
Fixing On Request
Colour ●

Height 500 mm
Width 300 mm
Fixing On Request
Colour ●



TRUCK LINE



TRUCK LINE



Heavy Load

Height 150 mm
Length 500, 750, 1000, 1250, 1500, 1750, 2000,
2250, 2500, 3000, 4000 mm
Fixing Included
Colour ●



COLUMN PROTECTIONS

10

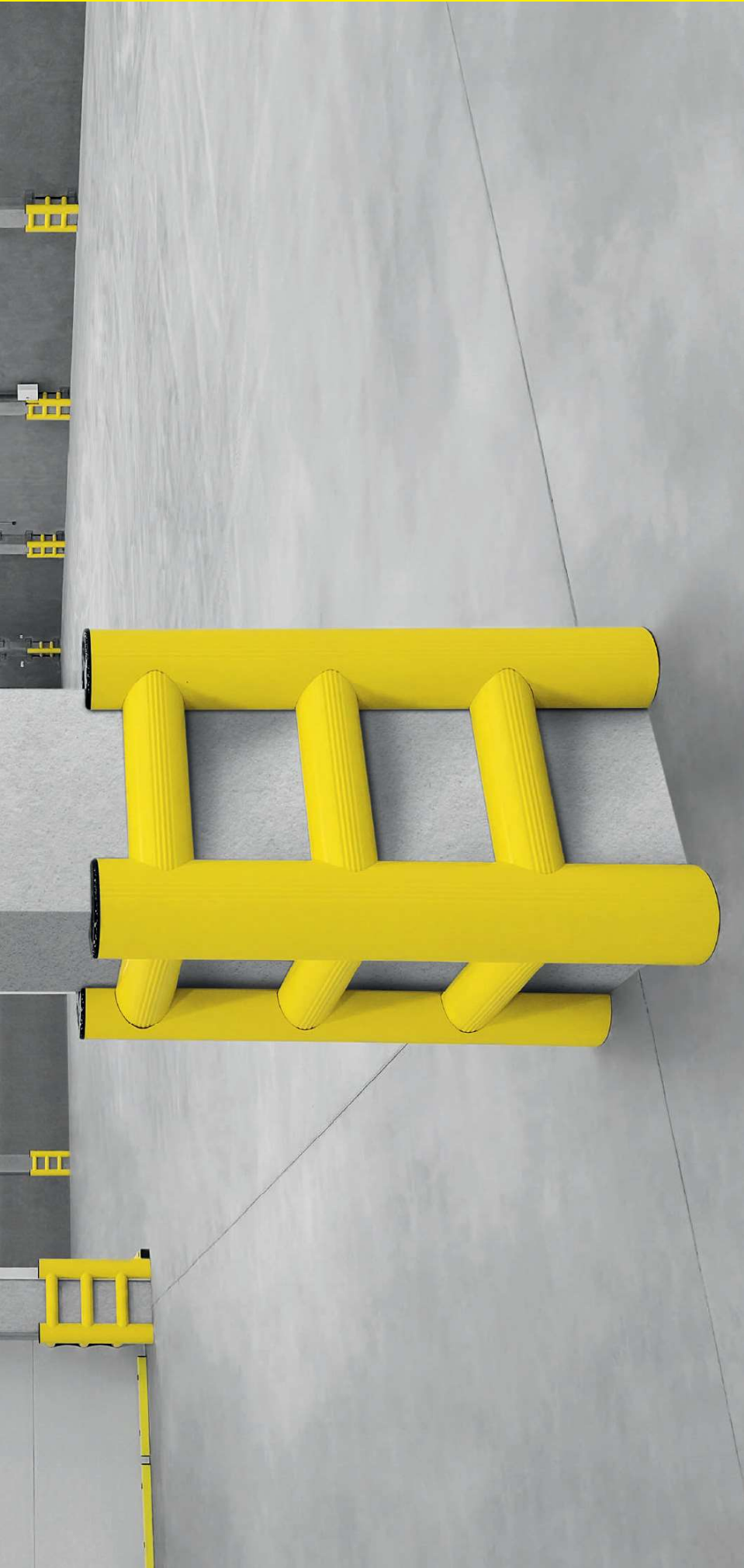

Bumper system specific for columns protection, strongly resistant to impacts from moving vehicles of different loads.

Sistema di profili specifico per la protezione delle colonne dai carrelli in movimento di varie portate.

Nouveau système bumper, spécifique pour protéger les poteaux contre les mouvements des chariots.

Sistema de perfiles específico para la protección de las columnas de los carros en movimiento de diferentes capacidades.

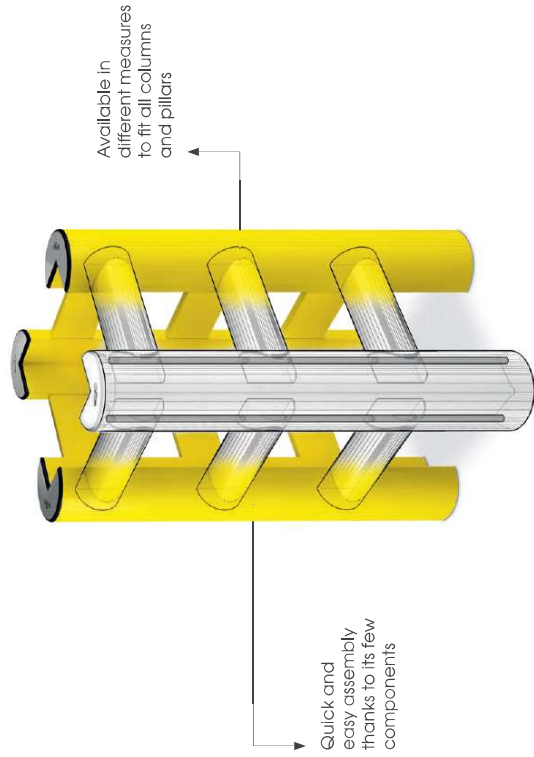

Available in different measures to fit all columns and pillars

Quick and easy assembly thanks to its few components

HUG TOWER

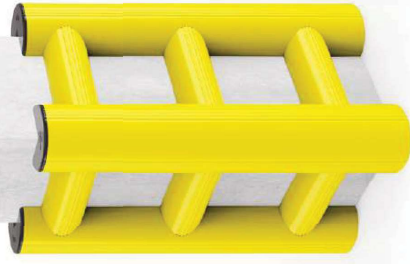

CHOOSE THE HEIGHT YOU NEED!

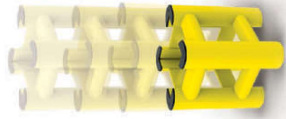

AVAILABLE ALSO:

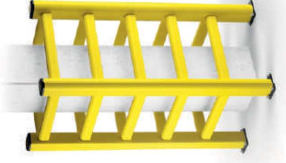

TOWER PROTECTION

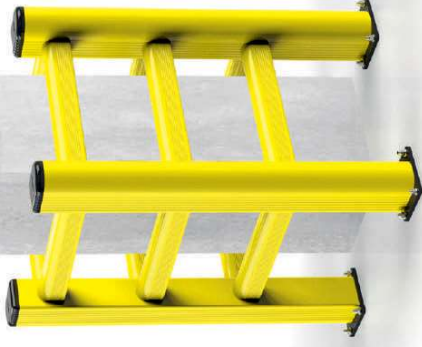

MINI HUG TOWER



Heavy Load
Height 1100 mm
Fixing Included
Colour ●

HUG TOWER



Heavy Load
Height 730, 1090, 1450, 1810 mm
Available (1090 mm only)
Fixing Included
Colour ●

TOWER PROTECTION



Heavy Load
Height 800, 1100, 1900 mm
Available (1100 mm only)
2/3 Sides Fixing Included
Colour ●

TOWER LINK 150/1



Heavy Load
Height 1100 mm
2/3 Sides Available
Fixing Included
Colour ●

TOWER LINK 150/2

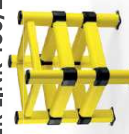

Heavy Load
Height 1100 mm
2/3 Sides Available
Fixing Included
Colour ●

TOWER LINK 150/3



Heavy Load
Height 1150 mm
2/3 Sides Available
Fixing Included
Colour ●



COPRO

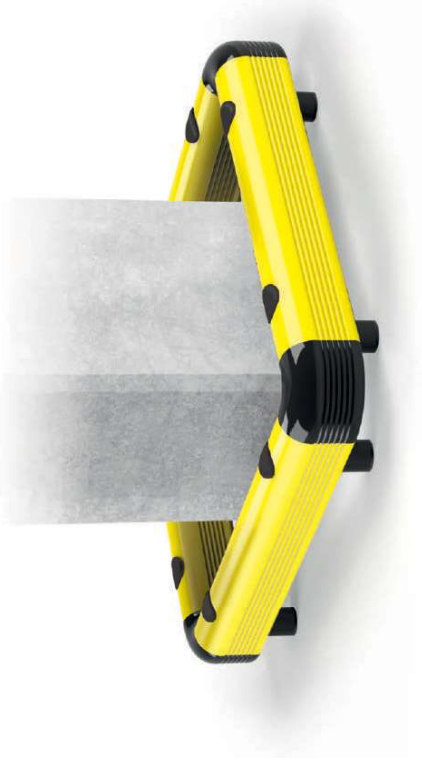

COPRO 90

COPRO 150



Height 140 mm
Available 2/3 Sides
Fixing Included
Colour ●●



Height 200 mm
Available 2/3 Sides
Fixing Included
Colour ●●



SOFT HUG

COMPACT & SOFT

HOOK AND LOOP CLOSURE



SOFT HUG



Height 1800 mm
Width 80, 100, 150, 200, 250, 300, 400, 500, 600 mm
Colour ●

CHOOSE THE SIZE YOU NEED!

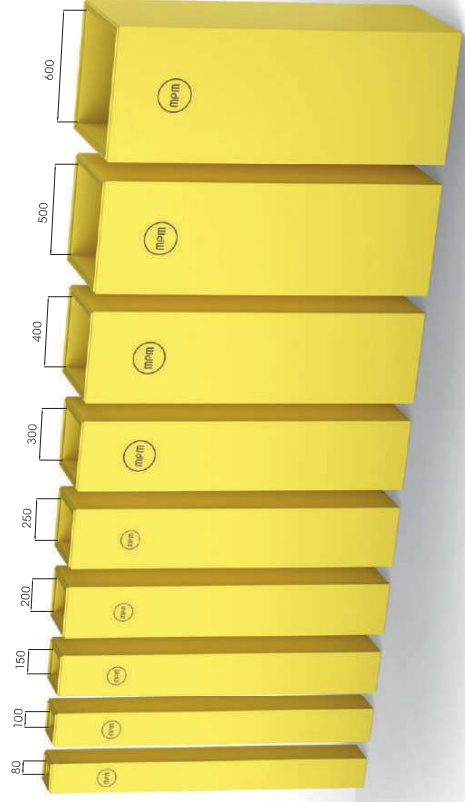

CORNER PROTECTIONS

11



Designed to protect pillars and columns or external corners of walls and panels.

Realizzato per proteggere pilastri e colonne o angoli esterni di muri e pannelli.

Étudié pour protéger les poteaux et les colonnes ou les angles extérieurs de murs et de panneaux.

Realizado para proteger pilares y columnas o esquinas exteriores de paredes y paneles.

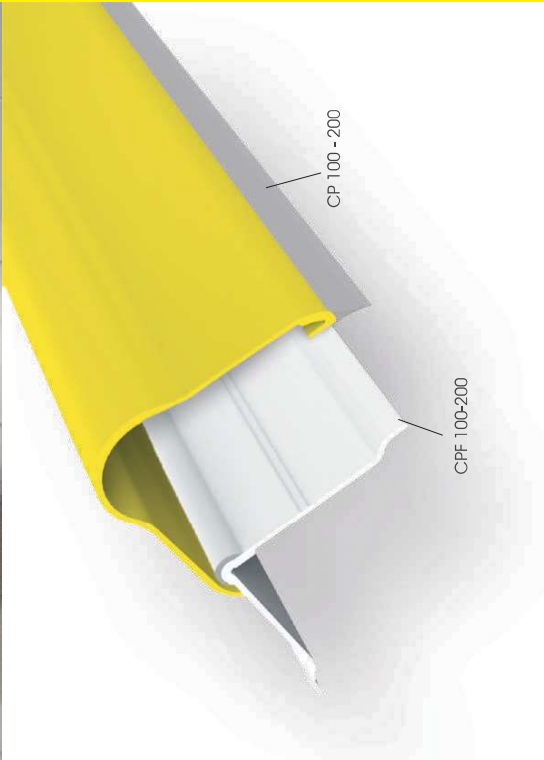

CP

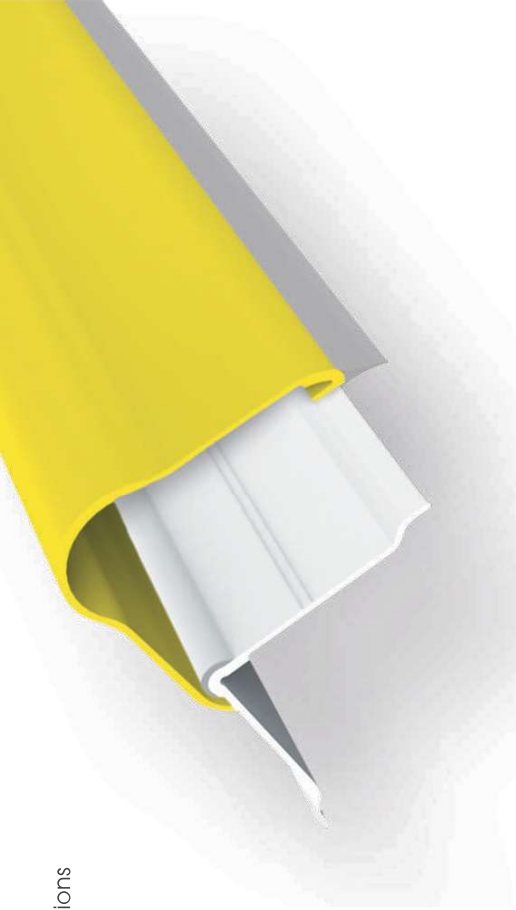





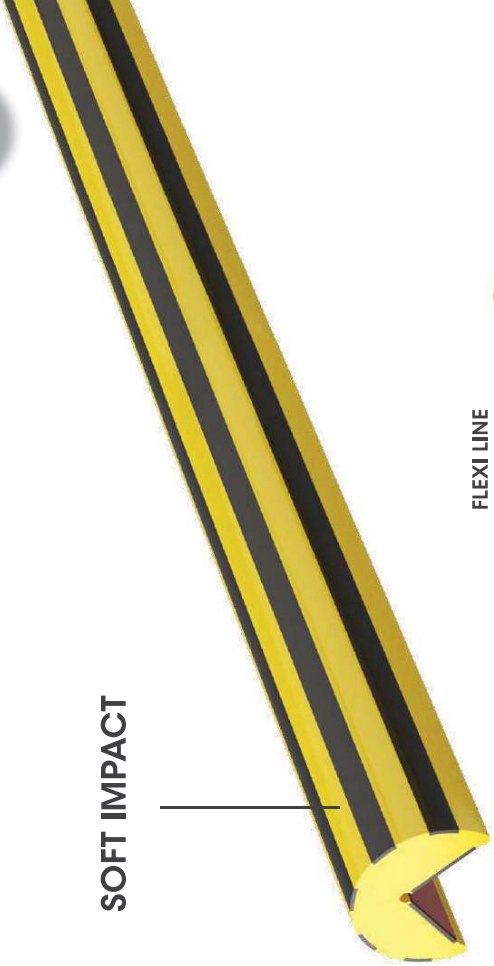

FLEXI LINE

SOFT IMPACT



DOUBLE-SIDED TAPE FIXING

<p>CP 100</p> 	<p>Length 4,000 mm Packing 10 pcs / box Colour M B E F</p> <p>Length 2,000 mm Packing 10 pcs / bag Colour M</p>	<p>CP 200</p> 	<p>Length 4,000 mm Packing 2 pcs / bag Colour M B E</p> <p>Length 2,000 mm Packing 2 pcs / bag Colour M</p>
<p>CPF 100</p> 	<p>Length 4,000 mm Packing 10 pcs / box Length 2,000 mm Packing 10 pcs / bag</p>	<p>CPF 200</p> 	<p>Length 2,000, 4,000 mm Packing 2 pcs / bag</p>
<p>CPT 100</p> 	<p>Packing 40 pcs / box Colour B E F</p>	<p>CPT 200</p> 	<p>Packing 20 pcs / box Colour B E</p>

FLEXI LINE



Length 1,000, 3,000 mm
Diameter Ø 39 mm
Colour

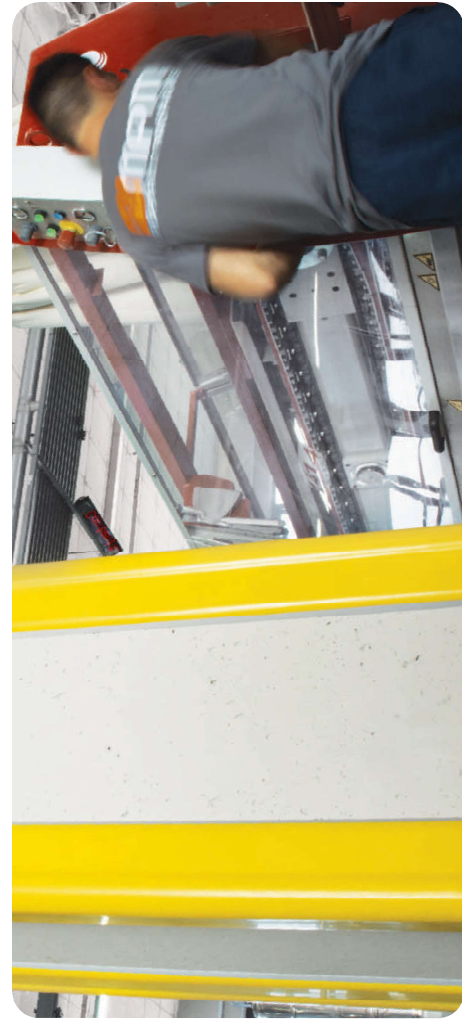



Innovative protection systems for walls and panels.
Easy to install and clean. Fully equipped with corner caps and buttons.

Sistemi innovativi di protezione per pareti e pannelli.
Facile da installare e pulire. Completo di angolari e tappi.

Systèmes de protection innovants pour les murs et les panneaux.
Facile à installer et à nettoyer. Complété de bouchons d'angles et d'embouts.

Sistemas de protección innovadores para paredes y paneles.
Fácil de instalar y limpiar. Completo de esquinas y tapas.

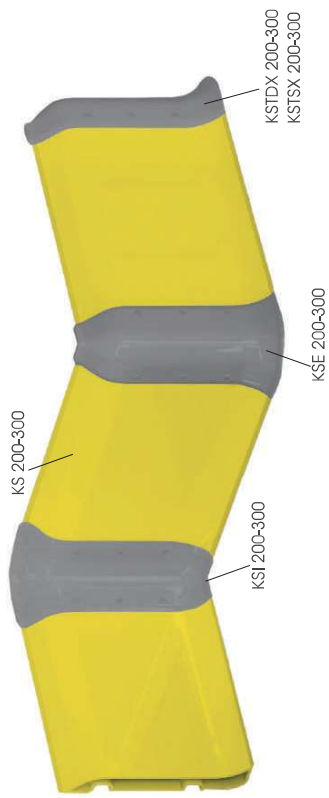

PLEX

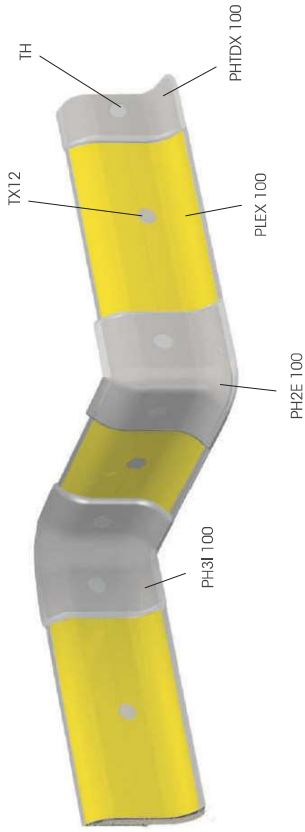

PLEX 100
 Height 100 mm
 Length 4,000 mm
 Packing 8 pcs / box
 To be complete with TX12 (100 pcs bag)
 Colour **M** **X**



PH2I 100
 Height 100 mm
 Packing 50 pcs / box
 To be complete with TH
 Colour **X**



PHJ 100
 Height 100 mm
 Packing 100 pcs / box
 To be complete with TH
 Colour **F** **X**



PH2E 100
 Height 100 mm
 Packing 50 pcs / box
 To be complete with TH
 Colour **X**



PH3I 100
 Height 100 mm
 Packing 50 pcs / box
 To be complete with TH
 Colour **X**



PHDX/SX 100
 Height 100 mm
 Packing 100 pcs / box
 To be complete with TH
 Colour **X**

KERB

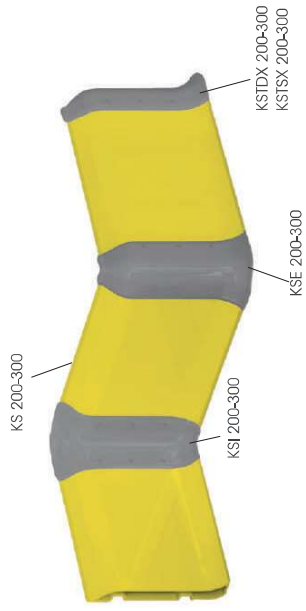

KS 200
 Height 200 mm
 Length 4,000 mm
 Depth 54 mm
 Packing 3 pcs / box
 Colour **M** **B** **E**



KS 300
 Height 300 mm
 Length 4,000 mm
 Depth 77 mm
 Packing 1 pcs
 Colour **M** **E**



KEPF 200/300
 Height 170 mm (200)
 255 mm (300)
 Packing 50 pcs / box (200)
 20 pcs / box (300)
 Colour **X**



KSE 200/300
 Height 200 mm
 300 mm
 Packing 20 pcs / box (200)
 10 pcs / box (300)
 Colour **B** **E**



KSJ 200/300
 Height 200 mm
 300 mm
 Packing 20 pcs / box (200)
 10 pcs / box (300)
 Colour **B** **E**



KSTDX/SX 200/300
 Height 200 mm
 300 mm
 Packing 20 pcs / box (200)
 10 pcs / box (300)
 Colour **B** **E**



KSI 200/300
 Height 200 mm
 300 mm
 Packing 20 pcs / box (200)
 10 pcs / box (300)
 Colour **B** **E**



KSJ 200 LT
 Height 200 mm
 Packing 20 pcs / box
 Colour **X**

FOR LOW TEMPERATURES



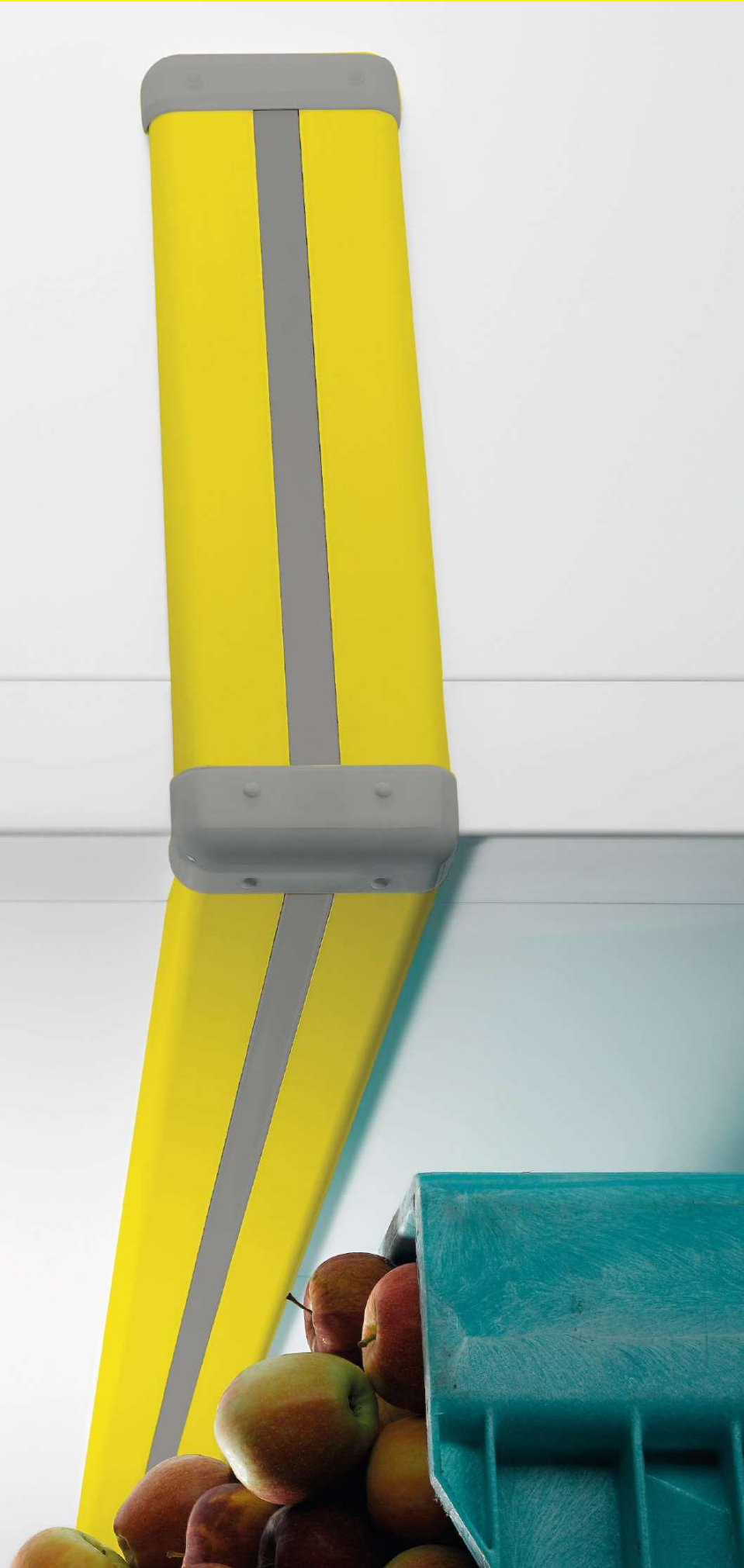

Solutions designed to protect walls in all industrial spaces. Available with fixed caps with hidden fixings to ensure high hygiene.

Soluzioni progettate per proteggere le pareti in tutti gli spazi industriali. Disponibili con tappi fissi e fissaggi nascosti per garantire un'igiene elevata.

Solutions conçues pour protéger les murs dans tous les espaces industriels. Disponibles avec des bouchons fixes et des fixations cachées pour assurer une hygiène élevée.

Soluciones diseñadas para proteger paredes en todos los espacios industriales. Disponibles con tapas fijas y fijaciones ocultas para garantizar una alta higiene.



WP

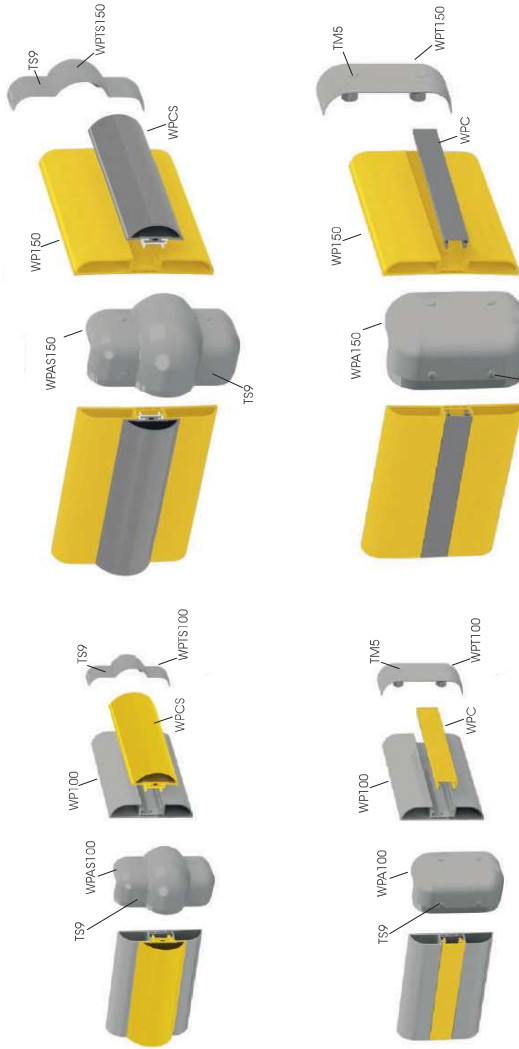

WP 100

Length 4,000 mm
Height 100 mm
Depth 21 mm
Packing 8 pcs / box
Colour B E F



WPC

Length 4,000 mm
Height 27 mm
Depth 13 mm
Packing 16 pcs / box
Colour A B M D E F G H I



WPT 100/150

Height 100, 150 mm
Width 22, 52 mm
Packing 50 pcs / box
To be completed with TM5
Colour B E



WPA 100/150

Height 100, 150 mm
Packing 20 pcs / box
To be completed with TS9
Colour B E



WP 150

Length 4,000 mm
Height 150 mm
Depth 21 mm
Packing 4 pcs / box
Colour M B E



WPCS

Length 4,000 mm
Height 62 mm
Depth 22 mm
Packing 8 pcs / box
Colour A B M D E F G H I



WPTS 100/150

Height 100, 150 mm
Packing 20 pcs / box
To be completed with TS9
Colour B E



WPAS 100/150

Height 100, 150 mm
Packing 20 pcs / box
To be completed with TS9
Colour B E

ASP

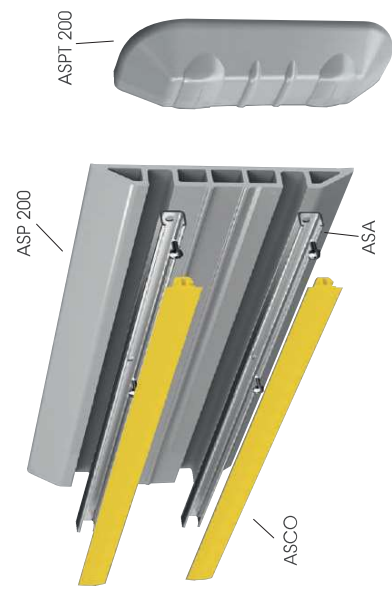

ASP 200

Length 4,000 mm
Height 200 mm
Depth 20 mm
Packing 2 pcs / box
Colour M B



ASCO

Length 32,000 mm
Height 25 mm
Packing 2 pcs / box
Colour A B M D E



ASPT 200

Height 200 mm
Packing 10 pcs / box
Colour B



ASA

Material Aluminium
Length 4,000 mm
Height 13.5 mm
Width 18 mm
Packing 8 pcs / bundle

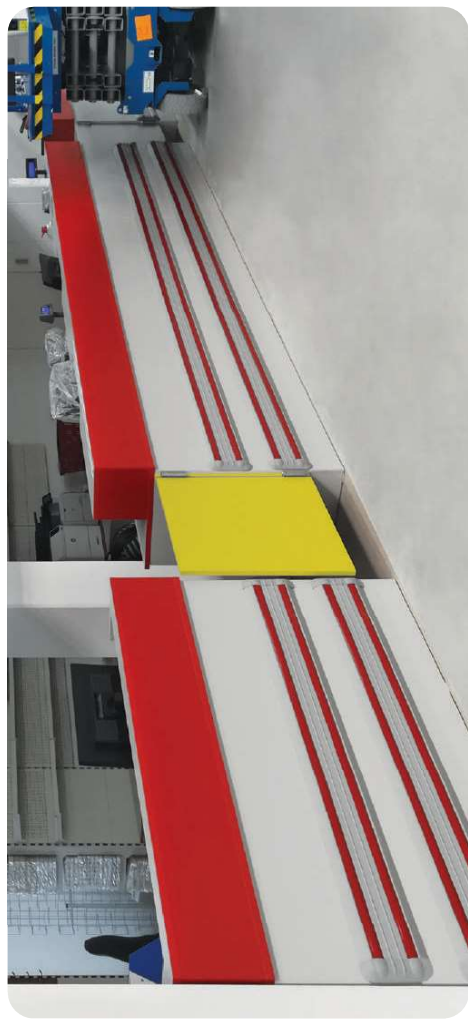



WALL HUG



Light Load
 Length 1,000, 2,000, 3,000, 4,000 mm
 Height 130 mm
 Depth 70 mm
 Fixing Not included
 Colour ●

WALL BFLEX



Light Load
 Length 1,000, 2,000, 3,000, 4,000 mm
 Height 300 mm
 Depth 80 mm
 Fixing Not included
 Colour ●

WALL BFLEX MODULAR



Light Load
 Height 300 mm
 Depth 80 mm
 Standard 1000 - 2000mm
 Module (250 Increments)
 Fixing Not included
 Colour ●

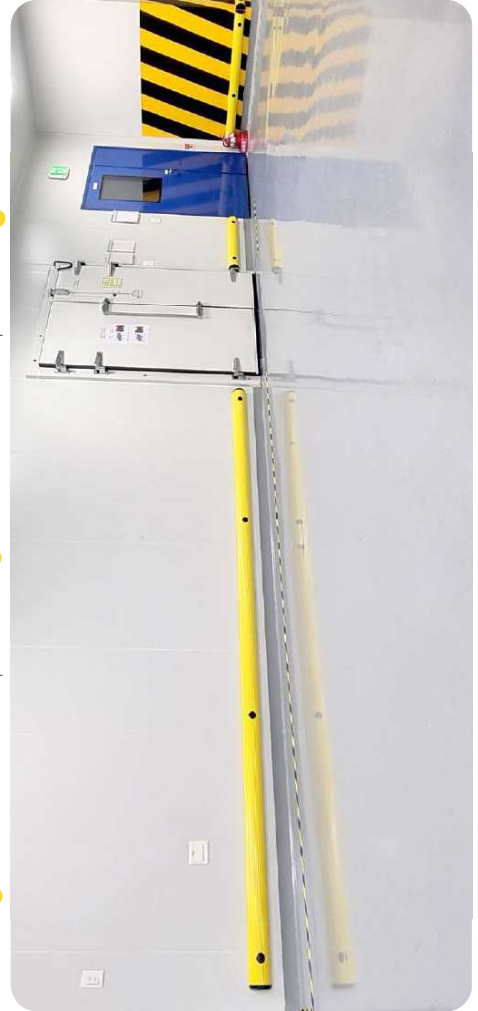



MPM accessories are designed to create a safe working environment.

Gli accessori MPM sono ideati per creare un ambiente di lavoro sicuro.

Les accessoires MPM sont conçus pour créer un environnement de travail sûr.

Los accesorios MPM están diseñados para crear un entorno de trabajo seguro.

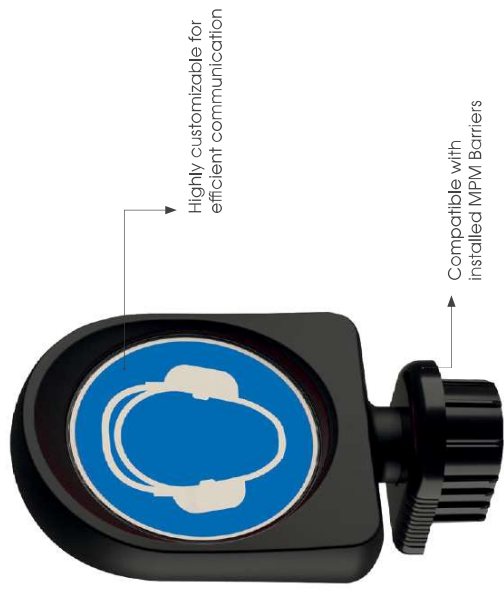

VISIBOARD



VISIBOARD



Sign
Width 200 mm
240 mm



VISIPOLE



Heavy Load
Height 1500 mm
Colour

SOFT BOLLARD

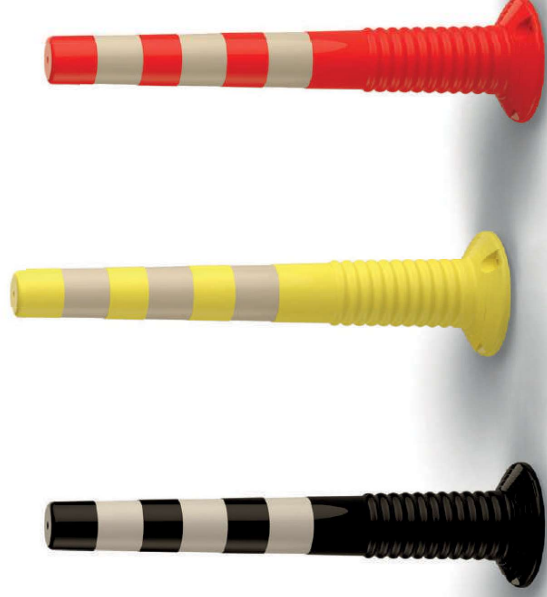

SOFT BOLLARD

Height 770 mm
Fixing On Request!
Colour



REMOVABLE PLATE

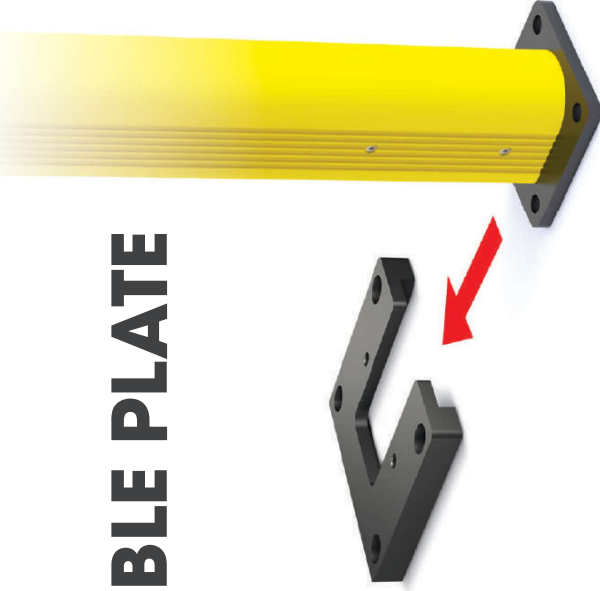

KIT 90 RE COVER



Height 22 mm
 Width 182 mm
 Depth 136 mm
 Available For: SM / FENCE 90 / HR / PED 90 / GRD 90 / LINK 120

KIT 150 RE COVER



Height 24 mm
 Width 242 mm
 Depth 176 mm
 Available For: LM / FENCE 150 / PED 150 / GRD 150 / LINK 150



CABLE COVER

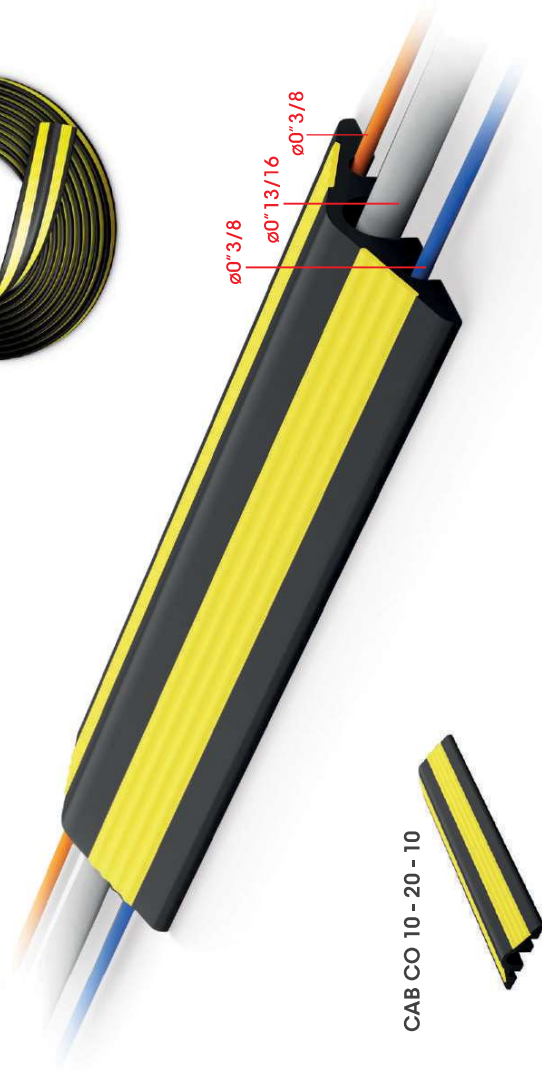

CAB CO 10 - 20 - 10



Length 1,000, 3,000, 10,000 mm
 Packing 8 pcs / box (1,000/3,000 mm)
 1 pcs / box (10,000 mm)



GENIUS

THE LENGTH THAT YOU WISH

CUT THE RAIL AND DRILL IT

Do you need to modify the length of your protections?

With our innovative Genius system, you can customize your barriers according to your needs.

Vuoi modificare la lunghezza delle tue protezioni?

Con il nostro innovativo sistema Genius potrai personalizzare le tue barriere, in base alle tue esigenze.

Besoin de modifier la longueur de vos protections?

Avec notre système innovant Genius, vous pouvez personnaliser vos barrières selon vos besoins.

¿Necesitas modificar la longitud de tus protecciones?

Con nuestro innovador sistema Genius, puedes personalizar tus barreras según tus necesidades.



GR90
GR70

CLIP 90

CUSTOMIZE YOUR BARRIER

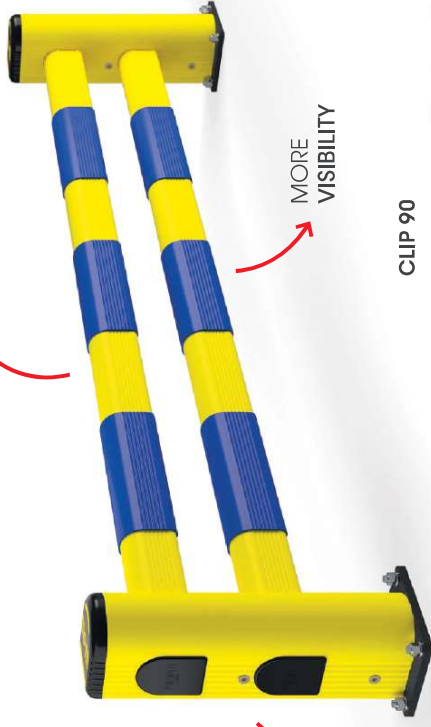

EASY TO INSTALL

MORE VISIBILITY

CLIP 90



Length 300 mm
Suitable LM, PED 150, TOWER PROTECTIONS, DP 150, SWING GATE
Colour



WORLD'S UNIQUE SYSTEM!

YOUR CUSTOMIZED BARRIER



FOR PEDESTRIAN BARRIER RAILS 70/90



FOR PEDESTRIAN BARRIER CORNER RAILS 70/90

FOR HUG TOWER

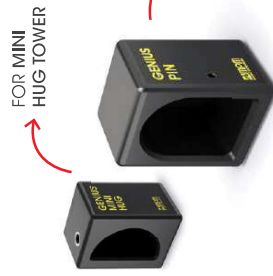

FOR MINI HUG TOWER

FOR PIN



FOR GR150



Innovation never stops. Our R&D department has been working on new solutions that will greatly aid you in the creation of a safer warehouse. Smart solutions are the future of safety!

L'innovazione non si ferma mai.

Il nostro reparto Ricerca e Sviluppo sta lavorando su nuove soluzioni che vi aiuteranno notevolmente nella creazione di un magazzino più sicuro. Le soluzioni intelligenti sono il futuro della sicurezza!

L'innovation ne s'arrête jamais.

Notre département R&D travaille sur de nouvelles solutions qui vous aideront grandement dans la création d'un entrepôt plus sûr. Les solutions intelligentes sont l'avenir de la sécurité!

La innovación nunca se detiene.

Nuestro departamento de I+D ha estado trabajando en nuevas soluciones que te serán de gran ayuda en la creación de un almacén más seguro. ¡Las soluciones inteligentes son el futuro de la seguridad!



Simple and very efficient system to avoid collisions

Sensors capable of detecting incoming traffic

SHUTTLE

DUAL
SENSOR



SHUTTLE



Height 200 mm
Width 236.5 mm
Depth 128.5 mm
Range detection 7,000 - 8,000 mm
Colour ●



Piezoelectric
BUZZER



NEW

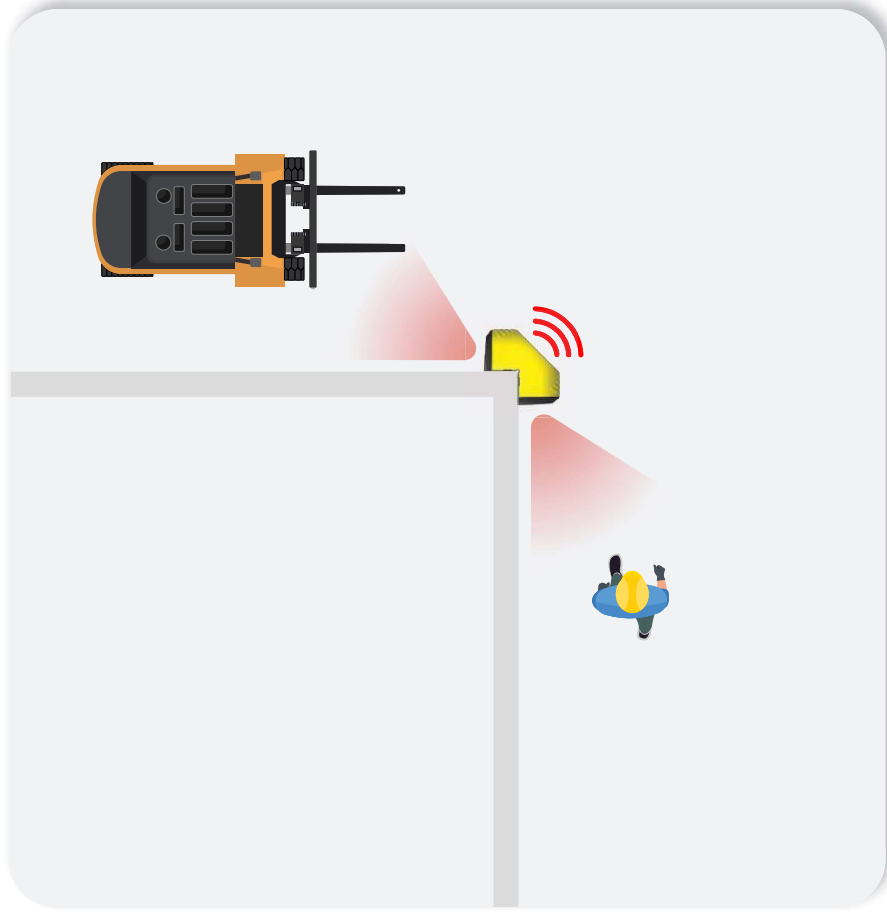

Our SHUTTLE can warn you of Possible collisions around corners.

It can detect incoming traffic from both ends and, if a collision is possible, will warn you with audio and visual cues. It can spot all types of moving object, from the largest to the smallest.

Il nostro SHUTTLE può avvisarti di possibili collisioni intorno agli angoli.

Può rilevare il traffico in arrivo da entrambe le direzioni e, se c'è la probabilità di una collisione, ti avviserà con segnali acustici e visivi. Può individuare tutti i tipi di oggetti in movimento, dai più grandi ai più piccoli.

Notre SHUTTLE peut vous avertir des collisions possibles autour des coins.

Il peut détecter la circulation entrante des deux côtés et, en cas de risque de collision, vous avertira par des signaux audio et visuels. Il peut repérer tous les types d'objets en mouvement, du plus grand au plus petit.

Nuestro SHUTTLE puede advertirte de posibles colisiones alrededor de las esquinas.

Puede detectar el tráfico entrante desde ambos extremos y, si es posible una colisión, te advertirá con señales auditivas y visuales. Puede identificar todo tipo de objetos en movimiento, desde los más grandes hasta los más pequeños.

SAFE WAY

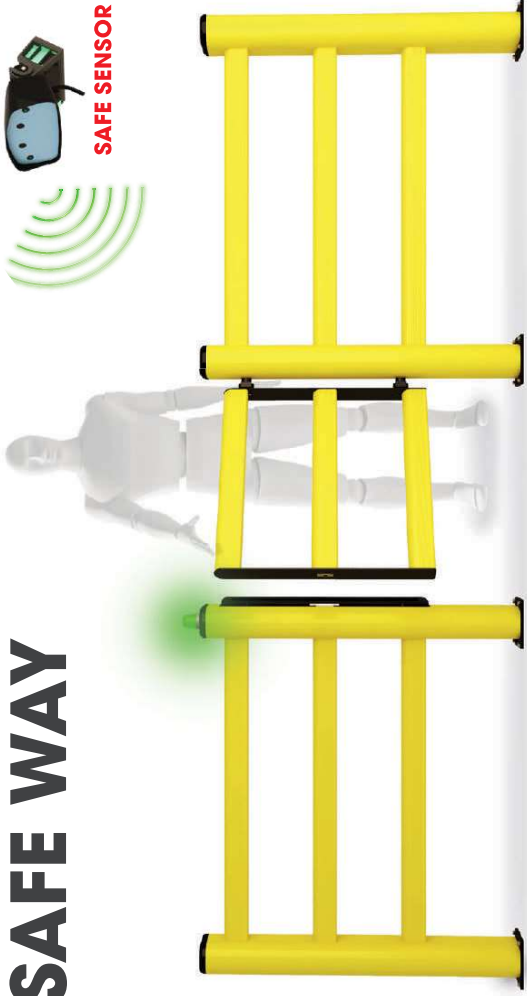

DP 150 SAFE WAY



Width
Fixing
Colour

Min 400 mm - Max 1,000 mm
(50 increments)
Included

●
●



SAFE WAY IS THE RIGHT WAY

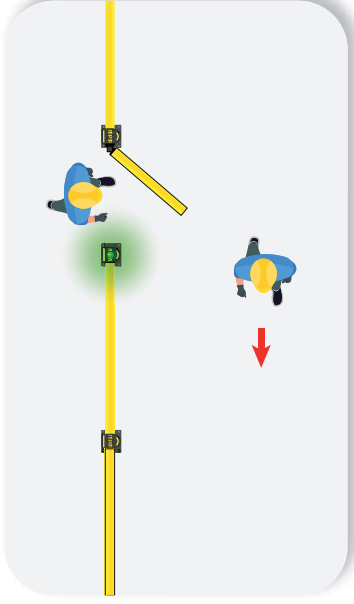

Safe Way determines if the crossing is safe and distinguishes vehicles from pedestrians.

Safe Way determina se l'attraversamento è sicuro e distingue i veicoli dai pedoni.

Safe Way détermine si la traversée est sécurisée et distingue les véhicules des piétons.

Safe Way determina si el cruce es seguro y distingue los vehículos de los peatones.

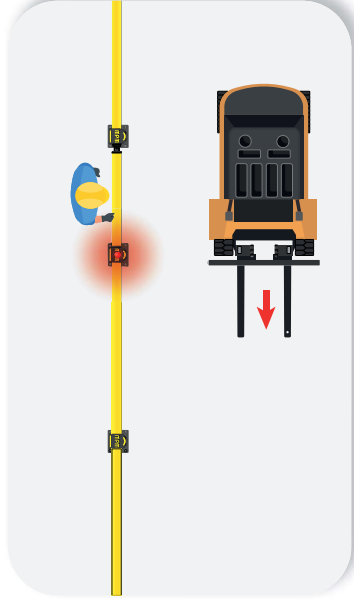

It stops when it detects oncoming vehicular traffic.

Si blocca quando rileva traffico veicolare in arrivo.

Il s'arrête lorsqu'il détecte la circulation automobile arrivante.

Se detiene cuando detecta tráfico vehicular entrante.

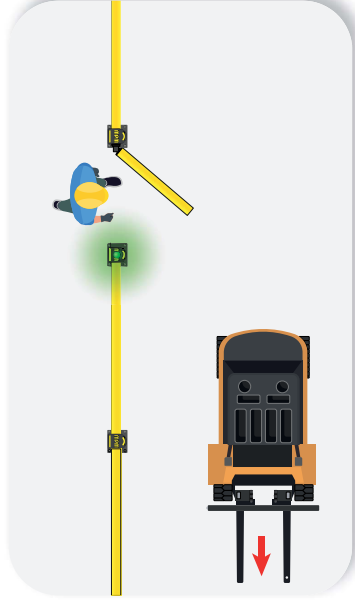

Safe Way allows passage when the vehicle no longer poses a danger.

Safe Way consente il passaggio quando il veicolo non rappresenta più un pericolo.

Safe Way permet le passage lorsque le véhicule ne représente plus un danger.

Safe Way permite el paso cuando el vehículo ya no representa un peligro.



Fixing accessories



S12 - S16 - S20
HILTI
Hole required Ø 10-14-16
Galvanized steel.



B12 - B16 - B20
HILTI
Hole required Ø 22-28-32
Galvanized steel.



SF12 - SF16 - SF20 INOX
Hole required Ø 14-18-24
Stainless steel.



KIT ROD 70-120
HILTI
Hole required Ø 38-56
Galvanized steel.



AA12 - AA16
Hole required Ø 22-22
Galvanized steel.
For asphalt.



FR
HILTI CHEMICAL ANCHOR
300 ML



M12 - M16
HILTI
Hole required Ø 12-16
Galvanized steel.



S8FH - S12FH
HILTI
Hole required Ø 6-10
Galvanized steel.
Countersunk.



M12 - M16 INOX
Hole required Ø 12-16
Stainless steel.



KIT ROD 70-120 INOX
HILTI
Hole required Ø 38-56
Galvanized steel.



ASPHALT CHEMICAL
CHEMICAL ANCHOR
585 ML



WIT NORDIC
CHEMICAL ANCHOR
420 ML
(Installation in working cold rooms
with negative temperatures)

Fixing accessories



TM5
Hole required Ø 8.5
Neutral polyethylene, 100/500 Pcs. / bag.



TS9
Hole required Ø 5
White or grey nylon, 1000 Pcs. / bag.



TH
ABS,
100 Pcs. / bag.
RAL 9010 / 9002 / 9006 / 7040 / 7024 / Transparent.



TX12
ABS,
100 Pcs. / bag.
RAL 7035 / 9010



TB14 - TB20
Hole required Ø 4-5
Steel / aluminium (white for ø 4)
500 Pcs. / box.



COVER 150 RE
Galvanized steel and painted.



FIX P90
Galvanized steel and painted.



COVER 90 RE
Galvanized steel and painted.



FIX P90 INOX
Stainless steel.



FIX P150
Galvanized steel and painted.



FIX P150 FH
Galvanized steel and painted.
Countersunk.



FIX P150 INOX
Stainless steel.



SHOCK ABSORBER PAD
Soft material, optional for FIX P150.
(To be installed with S12x150)



FULL FRAME BASE
Galvanized steel and painted.

In collaboration with



Colours



ORANGE

LIGHT
YELLOW
RAL 1018

DARK GREY
RAL 7024

LIGHT GREY
RAL 7035

SILVER
RAL 9006

GREEN
RAL 6029

BLUE
RAL 5005

WHITE
RAL 9002

WHITE
RAL 9010

BLACK
RAL 9005

GREY
RAL 7040

RED
RAL 3002

MPM srl reserves the right, at any time, to introduce the necessary changes and improvements to its products.
Any small imperfection in the products and in the materials used are due to the processing method.
Any reproduction of this brochure, even in part, is forbidden.

Products marked with the  symbol are recommended for indoor use, as prolonged UV exposure may cause discoloration.

MPM srl reserves the right, at any time, to introduce the necessary changes and improvements to its products.
Any small imperfection in the products and in the materials used are due to the processing method.
Any reproduction of this brochure, even in part, is forbidden.



SOME OF OUR REFERENCES

THE WORLD'S TOP LOGISTICS
 PROFESSIONALS CHOOSE OUR
QUALITY MADE IN ITALY 



CERTIFICATION



The TÜV SÜD certification was re-confirmed for rack protectors, 100% designed and manufactured by MPM in compliance with European standard EN 15512; Obtaining the TÜV SÜD certification is the confirmation of the company's commitment to the pursuit of qualitative excellence in its products.

Riconfermata la certificazione TÜV SÜD per le protezioni per scaffalature ideate e prodotte da MPM in conformità con la normativa europea EN 15512; L'ottenimento della certificazione TÜV SÜD è la conferma dell'impegno dell'azienda nella ricerca dell'eccellenza qualitativa dei propri prodotti.

La certification TÜV SÜD, attribuée aux protections des montants conçues et fabriquées par MPM conformément à la norme européenne EN 15512, a été reconfirmée. L'obtention de la certification TÜV SÜD confirme bien l'engagement de l'entreprise dans la recherche de l'excellence qualitative de ses produits.

Se confirma nuevamente la certificación TÜV SÜD para las protecciones montadas, diseñadas y fabricadas por MPM de acuerdo con la Norma europea EN 15512; La certificación TÜV SÜD confirma el compromiso de la empresa en la búsqueda de una calidad excelente de sus productos.

OUR CERTIFIED PRODUCTS:

RP, RACK CORNER, LM, GRD 150, PED 90, GRIN 150

OUR INSTALLATIONS

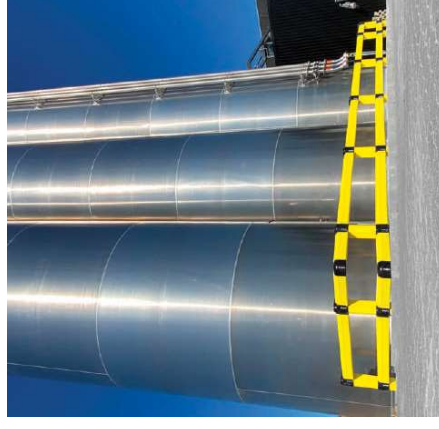

OUR INSTALLATIONS



OUR INSTALLATIONS

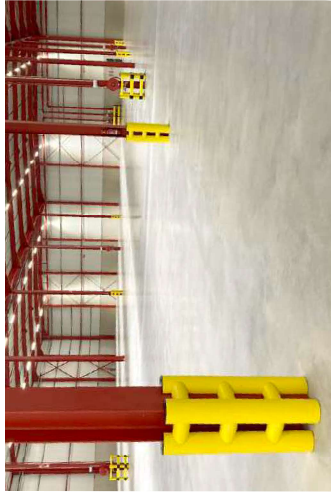

OUR INSTALLATIONS

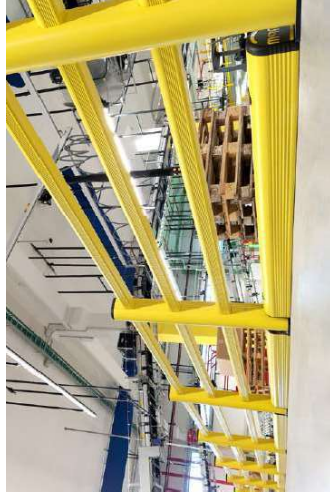

MPM states that:

The safety coefficient and consequent use of the products requires the compliance with the appropriate assembling and installation instructions as defined in the technical catalogue on the corporate website www.mpmprotections.com. Therefore, before buying and installing MPM solutions please consult the technical documentation provided by MPM.

Impact resistances indicated in the brochure, or in other documents, refer to laboratory tests and cannot take into account consequences determined by installation methods or peculiarities of the place where the products are installed. In an operational environment there is an almost infinite amount of variables, atmospheric condition, chemical conditions, salinity, exposure to UV light, vehicle type, speed and mass, routes, angles of impact, pedestrian routes, pedestrian behavior, catastrophic events, ground conditions and anchorage.

The data refers to an intact product which length is indicated on the test report and it can be affected by alterations from incorrect maintenance, wear and tear, as well as the methods and characteristics of installation (with specific reference to floor-mounted products); the weight, dimensions, colors and characteristics of the material refer to the sample and the conformity with the latter of the product supplied will be subject to normal production tolerance.

The warranty does not apply in the case of direct installation on asphalt without foundation plinths. Due to the particular nature and variety of this flooring, it is not possible to guarantee the impact resistance.

In addition, in the case of installation with foundation plinths on soil deemed unsuitable, the impact resistance cannot be guaranteed.

The height of the products hereby disclosed is calculated from the uppermost rail. Exception made only for LINK product lines. Length is calculated center to center. The product may be affected by uncontrollable environmental installation conditions. The standard operating temperature of MPM Flexible Protections is generally from +5 °C to +60 °C. For installations in low temperature environments up to -30 °C the alternative Frostex material should be required.

The fastness of the color and its brightness depend on wear and tear and weather conditions that can affect its intensity over time. For outdoor applications exposed to direct sunlight it is possible to choose the specific material Reflex Alpha or grey coloration.

Images in the brochure are for advertising purposes only and do not in any way represent how the products should be used. The images presented in this catalog are for commercial purposes and may not accurately correspond with the actual product. Small variations in color, design, and other features may occur. Full version of MPM products warranty available on corporate website www.mpmprotections.com





MADE IN
ITALY

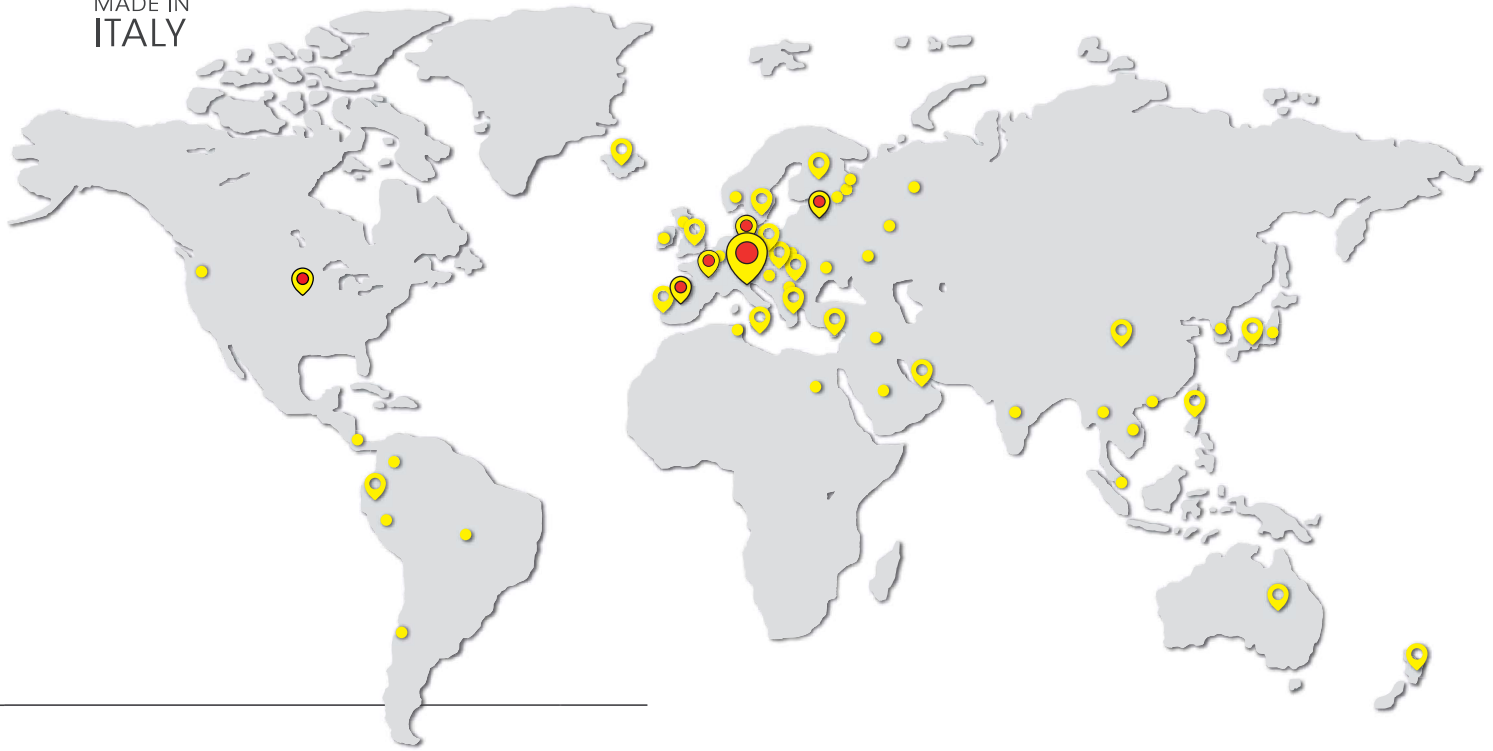

HEADQUARTER

MPM FLEXIBLE PROTECTIONS

Via Europa 2 35010 Fratte di S.
Giustina in Colle Padova · Italy
T +39 049 9301773
info@mpmpvc.com
www.mpmprotections.com



MPM USA

444 N Michigan Ave
Chicago, IL 60611
info@mpmprotectons.us
www.mpmprotections.us



MPM ESPAÑA

Av.da Eduardo Guitian, Num 11, Planta
3, Oficina 3, 19002 Guadalajara
T +34 949 146 001
info@mpmprotectons.es
www.mpmprotections.es



MPM DEUTSCHLAND

Hauptstraße 59
23879 Mölln
T +49 4542 853 65 80
info@mpmdeutschland.de
www.mpmdeutschland.de



MPM FRANCE

9 Allée Irène Joliot Curie 69800
SAINT PRIEST
T +33 41 21 20 500
info@mpmprotectons.fr
www.mpmprotections.fr



MPM POLSKA

Ul. Runowa 52
Tychy 43-100
T +48 500 465 569
kontakt@mpmpolska.pl
www.mpmprotections.pl



2025